

A review of principle and sun-tracking methods for maximizing solar systems output

Hossein Mousazadeh^a, Alireza Keyhani^{a,*}, Arzhang Javadi^b, Hossein Mobli^a,
Karen Abrinia^c, Ahmad Sharifi^b

^aDepartment of Agricultural Machinery Engineering, University of Tehran, Iran

^bAgricultural Engineering Research Institute, Karaj, Iran

^cFaculty of Mechanical Engineering, College of Engineering, University of Tehran, Iran

ARTICLE INFO

Article history:

Received 23 July 2008

Received in revised form 17 November 2008

Accepted 20 January 2009

Keywords:

Photovoltaic

Sun tracker

Azimuth

Microprocessor

Open loop control

ABSTRACT

Finding energy sources to satisfy the world's growing demand is one of society's foremost challenges for the next half-century. The challenge in converting sunlight to electricity via photovoltaic solar cells is dramatically reducing \$/watt of delivered solar electricity. In this context the sun trackers are such devices for efficiency improvement.

The diurnal and seasonal movement of earth affects the radiation intensity on the solar systems. Sun-trackers move the solar systems to compensate for these motions, keeping the best orientation relative to the sun. Although using sun-tracker is not essential, its use can boost the collected energy 10–100% in different periods of time and geographical conditions. However, it is not recommended to use tracking system for small solar panels because of high energy losses in the driving systems. It is found that the power consumption by tracking device is 2–3% of the increased energy.

In this paper different types of sun-tracking systems are reviewed and their cons and pros are discussed. The most efficient and popular sun-tracking device was found to be in the form of polar-axis and azimuth/elevation types.

© 2009 Elsevier Ltd. All rights reserved.

Contents

1. Introduction	1800
2. Some astronomy	1801
3. Radiation on an inclined and tracking surfaces	1801
4. Energy gain in tracking systems	1802
5. Sun-tracking methods	1806
5.1. Passive trackers	1806
5.2. Active trackers	1806
5.2.1. Microprocessor and electro-optical sensor based	1807
5.2.2. Auxiliary bifacial solar cell based	1810
5.2.3. Date and time based	1811
5.2.4. Combination of sensor and date/time based	1813
6. Conclusion	1815
References	1816

1. Introduction

Finding sufficient supplies of clean energy for the future is one of society's most daunting challenges. Alternative renewable energy sources such as sun energy can be substituted for exceeding human energy needs. Covering 0.16% of the land on earth with

* Corresponding author at: Department of Agricultural Machinery Engineering, University of Tehran, P.O. Box 4111, Karaj, Iran. Tel.: +98 261 2808138; fax: +98 261 2808138.

E-mail address: akeyhani@ut.ac.ir (A. Keyhani).

Nomenclature

B	daily beam irradiation on horizontal plane (W/m^2)
B_0	extraterrestrial daily irradiation (W/m^2)
D	the monthly mean daily diffuse irradiation on a horizontal plane (W/m^2)
G	the daily global irradiation on a horizontal plane (monthly mean) (W/m^2)
K_T	clearness index
I	maximum radiation intensity (W/m^2)
S	projection of S_0 perpendicular to radiation beams (m^2)
S_0	collector area (m^2)
W_p	peak watt (W)
Z	zenith angle ($^\circ$)

Greek letters

α	elevation angle ($^\circ$)
β	inclination angle ($^\circ$)
γ_c	surface azimuth angle ($^\circ$)
γ_s	solar azimuth ($^\circ$)
δ	declination angle ($^\circ$)
θ	sun incidence angle ($^\circ$)
φ	geographic latitude ($^\circ$)
ω	hour angle ($^\circ$)

10% efficient solar conversion systems would provide 20 TW of power, nearly twice the world's consumption rate of fossil energy. Directly converting sunlight to electricity is accomplished via PV solar cells. The birth of the modern era of PV solar cells occurred in 1954, when D. Chapin, C. Fuller, and G. Pearson at Bell Labs demonstrated solar cells based on p–n junctions in single Si crystals with efficiencies of 5–6%. Peak watt (W_p) rating is the power produced by a solar module illuminated under the standard conditions: $1000 \text{ W}/\text{m}^2$ solar intensity, 25°C ambient temperature, and a spectrum related to sunlight passing through the atmosphere when the sun is at a 42° elevation from the horizon (defined as air mass 1.5; i.e., when the path through the atmosphere is 1.5 times than that when the sun is at high noon). Because of day/night and time-of-day variations in insolation and cloud cover, the average electrical power produced by a solar cell over a year is about 20% of its W_p rating [1].

A part of the incident energy is reduced by scattering or absorption by air molecules. The radiation that is not reflected or scattered and reaches the surface directly is called direct or beam radiation. The scattered radiation reaching the ground is called diffuse radiation. The albedo is the fraction of radiation reaching the ground that is reflected back to the atmosphere from which a part is absorbed by the receiver.

2. Some astronomy

The earth revolves around the sun in an elliptical orbit with the sun as one of the foci. The plane of this orbit is called the ecliptic. The time taken for the earth to complete this orbit defines a year. The relative position of the sun and earth is conveniently represented by means of the celestial sphere around the earth. The equatorial plane intersects the celestial sphere in the celestial equator, and the polar axis in the celestial poles. The earth motion round the sun is then pictured by apparent motion of the sun in the elliptic which is tilted at 23.45° with respect to the celestial equator. The angle between the line joining the centers of the sun

and the earth and its projection on the equatorial plane is called the solar declination angle (δ). This angle is zero at the vernal (20/21 march) and autumnal (22/23 September) positions.

The earth itself rotates at the rate of one revolution per day around the polar axis. The daily rotation of the earth is depicted by the rotation of the celestial sphere about the polar axis, and the instantaneous position of the sun is described by the hour angle ω , the angle between the meridian passing through the sun and the meridian of the site. The hour angle is zero at solar noon and increases toward the east. For observers on the earth's surface at a location with geographical latitude φ , a convenient coordinate system is defined by a vertical line at the site which intersects the celestial sphere in two points, the zenith and the nadir, and subtends the angle φ with the polar axis (Fig. 1). The great circle perpendicular to the vertical axis is the horizon [2].

The latitude (φ) of a point or location is the angle made by the radial line joining the location to the center of the earth with the projection of the line on the equatorial plane. The earth's axis of rotation intersects the earth's surface at 90° latitude (North Pole) and -90° latitude (South Pole). Any location on the surface of the earth then can be defined by the intersection of a longitude angle and a latitude angle.

The solar altitude angle (α) is defined as the vertical angle between the projection of sun's rays on the horizontal plane and direction of sun's rays passing through the point, as shown in Fig. 1. As an alternative, the sun's altitude may be described in terms of the solar zenith angle (θ_z) which is a vertical angle between sun's rays and a line perpendicular to the horizontal plane through the point ($\theta_z = 90 - \alpha$). Solar azimuth angle (γ_s) is the horizontal angle measured from south (in the northern hemisphere) to the horizontal projection of the sun's rays [3].

Surveys have been conducted to define relations between these parameters and calculating of solar positions. Walraven calculated the parameter for determining the position of the sun by a FORTRAN program. The computed parameters were; time, longitude of the sun, declination, local azimuth, elevation, sunrise and sunset in real times. It was mentioned that the position of the sun computed was within an accuracy of 0.01° [4].

3. Radiation on an inclined and tracking surfaces

The solar radiation data are usually given in the form of global radiation on a horizontal surface and PV panels are usually positioned at an angle to the horizontal plane; therefore, the energy input to the PV system must be calculated accordingly. The calculation proceeds in three steps. In the first step, the data for the site are used to determine the diffuse and beam components of the global irradiation on the horizontal plane. This is carried out by using the extraterrestrial daily irradiation, B_0 as a reference and calculating the ratio $K_T = G/B_0$, known as the clearness index where

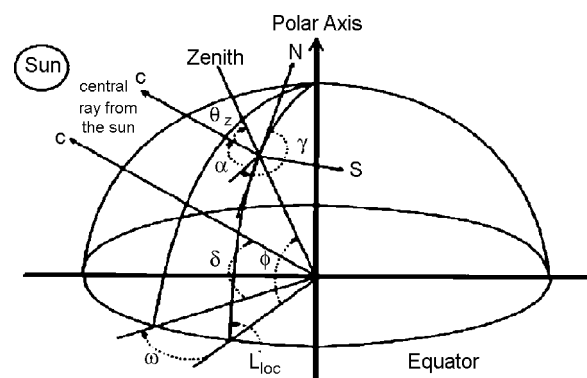

Fig. 1. Schematic representation of the solar angles [2].

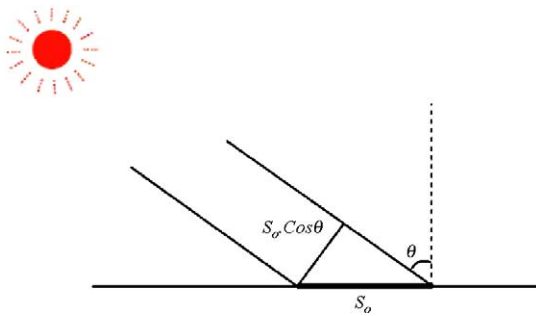

Fig. 2. Angle of incidence θ of the solar radiation [5].

G is the daily global irradiation on a horizontal plane (usually the monthly mean), and K_T describes the average attenuation of solar radiation by the atmosphere at a given site during a given month.

In the second step, the diffuse irradiation is obtained using the empirical rule that the diffuse fraction D/G of the global radiation is a universal function of the clearness index K_T (D is the monthly mean daily diffuse irradiation on a horizontal plane in W/m^2). Since $B = G - D$, this procedure determines both the diffuse and beam irradiation on the horizontal plane (B is daily beam irradiation on a horizontal plane).

In the third step, the appropriate angular dependence of each component is used to determine the diffuse and beam irradiation on the inclined surface. With allowance for the reflectivity of the surrounding area, the albedo can also be determined. The total daily irradiation on the inclined surface is then obtained by adding the three components [2].

Sun is moving across the sky during the day. In the case of fixed solar collectors, the projection of the collector area on the plane, which is perpendicular to the radiation direction, is given by function cosine of the angle of incidence (Fig. 2).

The higher the angle of incidence θ , the lower is the power. Theoretical calculation of the extracted energy in case of using tracking collectors is carried out by assuming that the maximum radiation intensity $I = 1100 \text{ W m}^{-2}$ is falling on the area which is oriented perpendicularly to the direction of radiation. Taking the day length $t = 12 \text{ h} = 43,200 \text{ s}$, intensity of the tracking collector which is always optimally oriented facing the sun is compared to that of a fixed collector which is oriented perpendicularly to the direction of radiation only at noon. The collector area is marked as S_0 .

(a) For a fixed collector, the projection area on the area oriented perpendicularly to the radiation direction is $S = S_0 \cos \theta$, where θ is changing in the interval $(-\pi/2, +\pi/2)$ during the day. The angular velocity of the sun moving cross the sky is $\omega = 2\pi/T = 7.27 \times 10^{-5} \text{ rad/s}$ and the differential of the falling energy is $dW = IS dt$. Neglecting the atmosphere influence, the energy per unit area is calculated for the whole day:

$$W = \int_{-21,600}^{+21,600} I S_0 \cos \omega t dt = I S_0 \left[\frac{\sin \omega t}{\omega} \right]_{-21,600}^{+21,600} = \frac{2IS}{\omega} = 3.03 \times 10^7 \text{ W s/m}^2 \text{ day} = 8.41 \text{ kWh/m}^2 \text{ day} \quad (1)$$

(b) For a tracking collector, by neglecting the atmosphere influence, the energy per unit area for the whole day is

$$W = IS_0 t = 4.75 \times 10^7 \text{ W s} = 13.2 \text{ kWh/m}^2 \text{ day} \quad (2)$$

Comparing Eqs. (1) and (2), 57% more energy is calculated for the latter case. This amount of energy can be obtained, for example, on the moon surface. The sun rays reaching the earth surface go through the thick layer of atmosphere. As we deviate from the noon, the solar insolation on the surface is weakened.

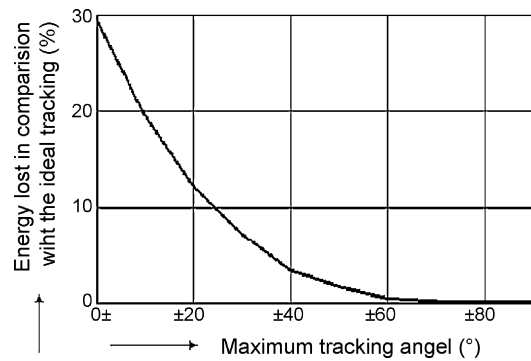

Fig. 3. Energy lost in dependence of the maximum tracking angle in comparison with the ideal tracking [5].

Also, in calculations, one can consider the day length longer than 12 h. Fig. 3 shows the dependence of the energy lost on the maximum tracking angle in comparison to that of an ideal tracking. It is clear that in tracking angles beyond $\pm 60^\circ$ no considerable energy gain is obtained [5].

4. Energy gain in tracking systems

Solar tracking can be implemented by using one-axis, and for higher accuracy, two-axis sun-tracking systems. For a two-axis sun-tracking system, two types are known as: polar (equatorial) tracking and azimuth/elevation (altitude–azimuth) tracking.

The solar tracker, a device that keeps PV or photo-thermal panels in an optimum position perpendicular to the solar radiation during daylight hours, increases the collected energy. The first tracker introduced by Finster in 1962, was completely mechanical. One year later, Saavedra presented a mechanism with an automatic electronic control, which was used to orient an Eppley pyrliometer [6].

Trackers need not point directly at the sun to be effective. If the aim is off by 10° , the output is still 98.5% of that of the full-tracking maximum. In the cloudiest, haziest locations the gain in annual output from trackers can be in the low 20% range. In a generally good area, annual gains between 30 and 40% are typical. The gain in any given day may vary from almost zero to nearly 100% [7].

Bione et al. compared the pumping systems driven by fixed, tracking and tracking with concentration PVs. The PV–V–trough system, consisted of four cavities and two PV modules to track the sun along its N–S axis, tilted at an angle of 20° towards the north. A theoretical simulation as well as experimental comparison between three cases was performed. By analyzing the daily characteristic curve for three given modes, the results showed that for a given irradiance, the pumped water flow rate was significantly different from one another. They proved that the benefit ratios obtained for water volume were higher than that for collected solar energy. The fixed PV, the PV with tracker and the concentrating-tracking systems pumped 4.9, 7.4 and 12.6 m^3/day , respectively [8].

Tomson analyzed the performance of the two-positional control of single stand-alone flat plate concentrator. The collector was rotated around its single tilted axis twice per day with predefined deflections. The effect of different tilt angles, initial tilt angle, initial azimuth, and azimuth angle of the deflected plane were evaluated on the daily and seasonal gain. The comparison of simulation and experimental results indicated that using a simple tracking drive with low energy input for a brief daily movement, increased the seasonal energy yield by 10–20% comparing to that of a fixed south facing collector tilted at an optimal angle [9].

Agee et al. examined the market trends and the field applications of solar tracking technologies, their associated costs,

maintenance requirements, and obtainable efficiency improvements. Their studies included hydraulic systems, program controlled systems and sensor based trackers such as single-axis type, dual-axis type as well as the polar-axis trackers. They concluded that a hydraulic based tracking system was suitable for low capacity installations. They found that polar-axis tracking systems' performance was similar to that of two-axis type, while its cost was equal to that of a single-axis tracking system [10].

Ai et al. proposed and compared the azimuth and hour angle three-step trackers. The day length on the south facing slope was divided into three equal parts in order to adjust the tilt angle. The sum of the direct radiation received in each time interval and the sky diffusion and ground reflection radiation during a day were considered to derive the mathematical formula for the three-step tracking system to estimate the daily radiation on planes. They concluded that for the whole year, the radiation on the slope with optimized tilt angle was 30.2% and that for the two-axis azimuth three-step tracking was 72% higher than that on the horizontal surface. No significant difference was found between one-axis azimuth three-step tracking and hour angle three-step tracking power [11].

Michaelides et al. investigated and compared the performance and cost effectiveness of a solar water heater with collector surface in four situations: fixed at 40° from the horizontal, the single-axis tracking with vertical axis, fixed slope and variable azimuth and the seasonal tracking mode where the collector slope is changed twice per year. To analyze the system, they used computer simulations using the TRNSYS simulation program for a thermo-siphon system. The simulation results showed that the best thermal performance was obtained with the single-axis tracking. In Nicosia, the annual solar fraction (fraction of load that is provided by solar radiation) with this mode was 87.6% compared to 81.6% with the seasonal mode and to 79.7% with the fixed surface mode, while the corresponding figures for Athens were 81.4%, 76.2% and 74.4%, respectively. From the economic point of view, the fixed surface mode was found to be the most cost effective [12].

Grass et al. compared non-tracking compound parabolic concentrator collectors with two novel tracking collectors: a parabolic trough and an evacuated tube collector with an integrated tracking reflector. Tracking was performed by the use of a magnetic one-axis tracking system. For ray-tracking analysis they used the ray-tracking code ASAP (Breault Research Organization Inc., 1999). To determine the optical efficiencies for direct and diffuse radiations and incidence angle modifiers of the collectors, measurements were carried out near the ambient temperature. The results showed that optical efficiencies for direct radiation can be increased during the day by using tracking systems. However, small tracking errors can have significant effects, if the step angle is low [13].

Helwa et al. studied the solar energy captured by different solar tracking systems. They calculated the solar energy collected by using measured global, beam and diffused radiations on a horizontal surface. Four systems were used in their experiments: fixed system with tilt angle of 40° due south, one-axis azimuthally tracking with tilt angle of 33° , one-axis tracking oriented in the N–S direction with 6° tilt angle and two-axis tracking system, one axis vertical and the other horizontal. They developed formulas for three modes of radiation that come in contact with the surfaces and wrote a computer program in BASIC to calculate and store daily radiation for each system. The comparison between calculated and measured data showed the annual average for the hourly root mean square difference (RMSD) values of 5.36, 9.07, 7.92 and 5.98 for the fixed, vertical axis tracker, tilted axis tracker and two-axis tracker systems, respectively. All values were in the acceptable range [14].

Lorenzo et al. designed a single vertical axis (azimuth axis) PV tracker and evaluated backtracking features. Each of 400 trackers

installed in Spain used a 0.25 hp standard AC motor. The tilt angle of the PV surfaces remained constant. They mentioned that the energy collected by an ideal azimuth tracker was about 40% higher than that corresponding to an optimally tilted static surface and 10% higher than that of horizontal axis tracking. They calculated the E–W and N–S shadowing between two adjacent trackers occurred in the morning or afternoon. They recommended that when shadowing occurs, it can be avoided by moving the surface's azimuth angle away from its ideal value, just enough to get the shadow borderline to pass through the corner of the adjacent surface (backtracking). Their comparison showed that the azimuth tracking land was 40% greater than static surface while the corresponding energy cost can be significantly reduced [15].

Mumba developed a manual solar tracking system for a PV powered grain drier working in two positions. A 12 V, 0.42 A, DC suction fan powered with PV was placed in the air inlet. To improve collector module efficiency, the sun was tracked $\pm 30^\circ$ from the horizontal. Mumba investigated the performance under four cases: PV fan-off without sun-tracking, PV fan-on without sun-tracking, PV fan-off with sun-tracking and PV fan-on with sun-tracking. In the sun-tracking cases the collector module angled manually eastward at 8.00 a.m. and westward at 2.00 p.m. while the collector module was tilted 15° from the horizontal to match the sun's elevation. It was concluded that from uniform air temperature point of view, the fan-on-sun-tracking case was the best, giving a temperature of 60°C . From uniform energy gain point of view, the sun-tracking cases performed superior to that of non-tracking ones. It was concluded that a solar air heater with manual sun-tracking facility can improve the thermal efficiency up to 80% [16].

Sangani et al. fabricated and tested a V-trough (2-sun) concentrator using different sun trackers to reduce generated electric cost with PV. Their tracking modes were seasonal tracking (A), one-axis N–S tracking (B) and diurnal tracking (C). Experimental results for I – V characteristic curves and output power from the PV module at an insolation level of 900 W/m^2 assembled at different tracking modes are shown in Fig. 4 [17].

Pavel et al. analyzed experimentally and theoretically the collected energy in original tracking and non-tracking bifacial and non-bifacial PV solar systems. The calculated and measured tracking effect showed an increase of 30–40% in collected energy while for tracking case with bifacial panels and reflector collecting solar radiation for the rear face gave an increase in collected energy of 50–60% for the same panel [18].

Helwa et al. compared the stationary and tracking PV systems to assess the power consumption of tracking systems and the effect of tracking accuracy on the system output. The compared systems were: a fixed system tilted 40° horizontally, one vertical axis

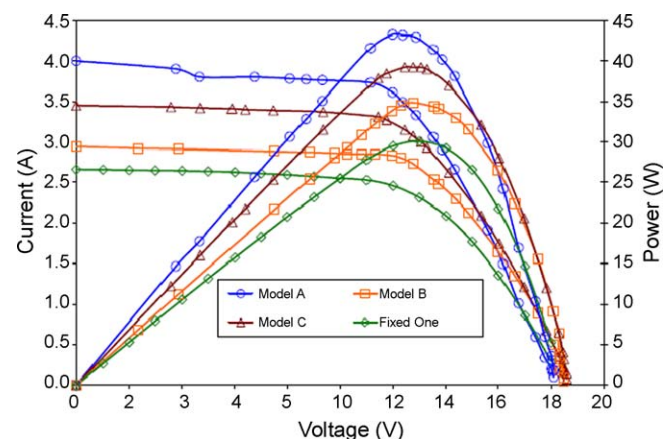

Fig. 4. I – V curves and power output for different V-troughs concentrator PV systems assembled according to model-A, model-B and model-C [17].

tracker (using time, date and site parameters for control), a 6° tilted axis parallel to the N–S direction (using time, date and site parameters for control) and two-axis azimuth/elevation tracker (controlled by microprocessor taking commands from a PC). Several revolution count sensor and limit switches were used. Their comparison curves among different solar tracking systems showed that the increase in annual radiation gain from the two-axis tracker, vertical axis tracker and tilt axis tracker over the fixed-tilt system was 30, 18 and 11%, respectively. The power consumption due to microprocessors, electric equipment, sensors, electrical switching and driving motors for tilted-axis tracker were 50 Wh/day and 22 Wh/day when the tracking error were $\pm 0.56^\circ$ and $\pm 10^\circ$, respectively [19].

Oladiran assessed the mean global radiation captured by flat surfaces inclined at $\varphi - 10^\circ$, φ , and $\varphi + 10^\circ$ (φ as latitude), while tilting the surface from 0° to 75° at 15° intervals azimuthally for three zones in Nigeria. The mean total solar flux captured by three collector inclinations and six surface azimuth angles was calculated theoretically and a computer program was written. For graphic presentation, a data file was created for each run of the program. The total radiation per day of year, the mean monthly radiation and mean annual radiation for three zones were evaluated. Oladiran concluded that for all azimuth angles, an inclination angle equal to φ produces the best all-year-round performance [20].

Chicco et al. experimentally assessed the production of the PV plants in the sun-tracking and fixed modes in three different sites. In the first site, 15 individual systems controlled by one coordinate tracking system were compared with a 0° azimuth and 36° elevation angles as fixed cases. In the second site, 90 individual systems with separate coordinate-controlled tracking were compared with 0° azimuth and 30° elevation fixed system. For the third site, the position of the sun-tracking system was being updated every 15 min and the fixed system maintained at a tilt angle of 30° with 35° elevation angle. The results showed that the average improvement, using the sun-tracking system, was 32.9 and 35.1% from the simulated values and 37.7 and 30.4% from the actual data for the first and second sites, respectively. For the third site, an annual improvement of 31.5% for the sun-tracking system was obtained [21].

Ibrahim constructed an electronically one-axis concentrating collector with an electric motor for forced circulation. The collector was hinged at two points for its tilt adjustment with a tightening screw to continuously track the sun from east to west through a range of 180° . The collector efficiency was measured for different values of mass flow rates. It was concluded that the collector efficiency increases (reaching the maximum value of 62%) as the mass flow rate increases [22].

Brunatte et al. investigated a two-stage concentrator with one-axis tracking system around a polar N–S axis. The half rim angle of the first concentrating stage was chosen to be equal to the sun's maximum declination of 23.5° . They tested the system for various conditions and theoretically calculated the concentration factor for E–W and N–S tracking. They concluded that thermodynamically, concentration factor increases by a factor of three. For the first prototype, concentration optical efficiency of 77.5% was measured at normal incidence [23].

Shaltout et al. designed and constructed a V-trough concentrator on a PV full tracking system. The system gave relatively high gain in the amorphous Si solar cell's power which was about 40% more than that without a concentrator. Their graphical comparison between concentrated horizontal and tracking radiation showed an increase in gain of about 23% for the latter one [24].

Baltas et al. evaluated the power output for fixed, step tracking and continuous tracking systems in several locations. They used direct radiation, total radiation on horizontal surface and dry bulb

temperature data for computer simulation. They stated that Freon-driven trackers are good for a flat plate array unlike for concentrating PV systems, due to their independence of good tracking accuracy. By comparing the energy output from various tracking systems for a typical year, they concluded that the two step tracking arrays (E–W direction varying twice per day, south facing tilt varying monthly) provides about 95% of the energy obtained from continuous tracking arrays. Also, the continuous tracking mode provided 33, 25.5 and 22.5% more energy in different locations over fixed arrays, respectively. Continuous tracking increased the energy production 29.2 and 33% over south facing fixed arrays, respectively, for reflection non-accounting and reflection accounting systems [25].

Gordon et al. studied the field layout, tracker and array geometry sensitivity in central station solar PV systems. Their calculations were based on hourly computer simulation models. They plotted curves for ground cover ratio (GCR) and maximum degrees of rotation angle effect on yearly energy losses in stationary and different tracking modes. The GCR was defined as the ratio of PV array area to total ground area for the system. The results showed that the shading losses increase with GCR for each system. The stationary and N–S horizontal axis tracking collectors (the last case gave 90% of the yearly energy for two-axis trackers) at low GCR values were the least sensitive and became substantial only at GCR above around 0.6. Polar axis tracking (one-axis tracking about N–S axis inclined at a tilt angle equal to latitude) was the best one-axis tracker, delivering around 97% of the yearly energy of two-axis trackers but it was too sensitive on GCR. Although two-axis tracking maximizes yearly energy production, it requires relatively a low GCR. They also concluded that the yearly energy sacrifice decreases with maximum rotation angle for every tracker [26].

Nann evaluated the potentials for tracking systems relative to the cost and irradiance received from a fixed (40°) system. It was mentioned although the fraction of direct normal irradiance on a surface normal to the sun was 54% greater than that of the fixed one, the surplus of irradiance received by one-axis tracking and two-axis tracking systems were 34 and 38%, respectively and at today's module costs, tracking the sun can improve the cost effectiveness of the PV plant by up to 20%. The comparison between three stationary, one-axis and two-axis tracking systems showed that irradiation received by one-axis tracker is nearly as the same as the two axis trackers; however its tracker cost is approximately half of that of the two-axis one [27].

Braun et al. calculated the optimum geometry for fixed and tracking surfaces. They evaluated theoretically the zenith, sun azimuth, surface azimuth and slope angles for one-axis and two-axis sun trackers and concluded that for a two-axis tracking surfaces, radiation beam is maximized when surface azimuth is equal to sun azimuth and surface slope is equal to zenith [28].

Dickinson assessed the long-term average annual radiation for fixed and tracking collectors. After data verification from several locations it was concluded: (a) tilting flat plate collectors at optimum angle $\varphi - 5^\circ$ increases annual collected radiation by only 10% over that of a horizontal collector; (b) a horizontal N–S axis tracker increases annual collected radiation by 15% that of a horizontal E–W axis tracker, while in the winter the E–W axis tracker collects 20% more radiation than that of the horizontal N–S axis; (c) a polar-axis tracker will have an average annual radiation about 10% more than that of a horizontal N–S axis tracker; (d) a two-axis tracker receives only a few percent more radiation compared to that of a polar axis tracker annually [29].

Neville calculated the solar insolation for fixed and tracking modes in different latitudes and orientations. The plotted curves for fixed, E–W tracking and ideal tracking modes as a function of latitude showed that ideal tracking unlike the two other modes

almost have the same behavior for different collector orientations. Also, the E–W tracking results in a collected energy is a close approximation to the ideal tracking case. It was concluded that the optimum detected insolation depends not only on the latitude, tracking mode and collector angle but also on weather climate, type of energy converter and the non-storing or storing techniques [30].

Felske evaluated the variation of azimuth and tilt angle on effectiveness of flat plate solar collectors. It was concluded that for a given tilt angle, the yearly energy collection is almost insensitive to azimuth angle until the vertical orientation is approached at which the collected energy actually increases with increasing the azimuth angle. In this case, the optimum tilt angle is quite insensitive to azimuth angle. For a given azimuth angle, an optimum collector tilt angle is between 3° and 10° less than the latitude. Finally, it was mentioned that even for locations having symmetric irradiation about solar noon it is desirable to orient the collector west of south, since afternoon temperatures are usually higher than morning temperatures [31].

Matthew et al. designed, constructed and assessed the performance of a sun tracker for fixed reference orientation estimation. Their sun tracker had the potential to provide three degree of freedom with good accuracy and high precision and capable of long distance navigation without use of physical properties such as Earth's magnetosphere or modern infrastructure. Unlike estimates derived from dead reckoning or integration of inertial rate sensors, in this system, the heading errors were fixed over time [32].

Kalogirou gathered relations for estimation of the angle of incidence for various modes of tracking. By applying a radiation model in equinoxes, 100, 73.8 and 89.1% to full tracking for E–W polar, N–S horizontal and E–W horizontal, respectively were obtained. It was mentioned that the percentages will be 91.7, 74 and 97.7 in summer solstice and 91.7, 86.2 and 60.9 in winter solstice, respectively for some trackers [33].

Grena estimated a new algorithm for determination of the solar positions with maximal error of 0.0027° over the period 2003–2023. Greenwich civil time, date, difference between Greenwich civil time and terrestrial time, longitude and latitude, pressure and temperature were the input data. Outputs from the algorithm were: right ascension, declination, hour angle, zenith and azimuth angles. It was concluded that considering both the quadratic error and the maximal error, the proposed algorithm reduces the error on the solar vector by 60–75% compared to similar algorithms [34].

Comsit et al. designed a synthesis linkage, based on multi-body systems method for dual axis sun-tracking in solar energy conversion systems. They identified all possible graphs based on spatiality of the multi-body system, type of the geometrical constraints (simple and/or compound), number of bodies and the mobility of the multi-body system. To be more reliable, they recommended decoupled motions for these tracking systems [35].

Splitt et al. evaluated an automated algorithm for solar tracking problems. This algorithm is based on difference between total hemispheric down welling broadband shortwave radiation and that calculated by adding the diffuse radiation component to the direct normal radiation component multiplied by the cosine of the zenith angle. They concluded that when the difference between these two become 40 W/m^2 , an error is occurred. When the total radiation is below 600 W/m^2 , the algorithm was not able to detect the tracker problem [36].

Stern et al. designed, fabricated, tested and demonstrated a modular and fully integrated 15-kW-AC, one-axis solar tracking PV power. The tracker used potentiometer and integral pendulum to provide a positive feedback signal to the tracker motor and actuator. It was concluded that single-axis solar tracking provides 20% more energy in a typical year than that of a fixed-axis PV

system. Also, the net reduction in the total cost of single-axis solar tracking grid connected PV power system was found to be 23.3% [37].

Naidoo et al. developed three algorithms for parabolic trough solar collector tracking. In the first method, they used discrete number of pulses to position the trough. The rotary encoder used in this project to provide feedback on the absolute angular position of the trough had 0.144° per pulse. In the second, method the trough is positioned in the N–S axis in order to track the sun in the E–W direction. In order to position the sun, a mathematical algorithm in a PLC programmed software was used along with longitude and latitude based on the geographical location of the trough. In the third system, a fuzzy logic controller based on an intelligent control algorithm was used. Fluid temperature, wind speed and trough position were inputs where trapezoidal form and drive speed were outputs. The relation between inputs and outputs was defined with IF–THEN rule. No report was provided for any comparison or efficiency evaluation [38].

Stolfi et al. designed and constructed a working prototype two-axis solar tracking and concentrating apparatus for a heliostat array. To actuate the necessary motion of the apparatus, two step motors were used. To provide a horizontal motion, the unit moves on a turntable controlled by a pair of worm gears. The reflective panel tilts up and down using a simple spring-driven hinge. In this system, a master unit is used to position the slaves. This is accomplished by both monitoring the output of the PV array and using an automatically generated database of previous known-good slave positions with corresponding reflected lights, solar position, and/or time of day values. The tests showed that the tracking increases the power output by increasing the output current. These tests also showed that the reflectors created uniform, concentrated light areas suitable for focusing onto the PV cells [39].

Appelbaum et al. in NASA Technical Memorandum evaluated the solar radiation on Mars for horizontal and different tracking PV arrays. They concluded that for a yearly operation, the average gain in insolation is about 7% more at latitude = 23.3°N and 21% at latitude = 47.4°N for the two-axis tracking surface compared to that of the horizontal surface. For dark days the difference in insolation for different modes was small indicating no significant advantage of the two-axis tracking. However, for clear skies the gain for N–S axis, E–W polar tracking was 15.9%, for vertical axis, azimuth tracking was 13.1%, for N–S horizontal axis, E–W tracking, constant rotational tracking speed was 13.0%, and for E–W horizontal axis, N–S tracking, maximum beam irradiance was 8.3% as compared to that of horizontal surface at latitude = 23.3°N [40].

Nafeh evaluated the optimum tilt of PV arrays by using maximum global insolation technique. Theoretically, they calculated the global insolation at solar noon, incident on an inclined PV array with a predefined tilt angle and simulated the case by MATLAB-SIMULINK to calculate the optimum tilt angle for every day, month or year. Comparison curves for daily adjusted tilt angle and insolation between proposed technique and the conventional technique were given. They concluded that if the tilt angle is daily or monthly adjusted to its optimal value, then the global insolation collected at solar noon using the proposed technique will be larger than that collected at solar noon using the conventional technique over all days of the year. It was found that to obtain maximum solar insolation, using both the latitude of the site and the sun declination is necessary to orient the PV arrays [41].

Drago evaluated an energy gain comparison between four flat plate collectors two of them were fixed, one with single cover and the other, double cover collector and two similar collectors with full tracking. The result showed that in the winter the total energy gain for tracking cases were more than 100% and 47% of that of the

single cover and double cover modes, respectively. The efficiencies of the single cover were 5.7% and 10.1%, respectively for fixed and tracking cases and the efficiencies of the double cover were 17.4% and 21.8%, respectively for fixed and tracking cases [42].

Gay et al. compared daily and annual energy-delivery performance for large-scale fixed-array and two-axis tracking photovoltaic generating systems and site sensitivities were also discussed. For the studied site, it was observed that a fixed-array system would use about 40% more modules than a two-axis tracking system, for equal annual energy collection [43].

5. Sun-tracking methods

The presence of a solar tracker is not essential for the operation of a solar panel, but without it, performance is reduced. Although solar trackers can boost energy gain of PV arrays, in their installation some problems such as cost, reliability, energy consumption, maintenance and performance must be considered.

All tracking systems have all/some of the following characteristics [44]:

- Single column structure or of parallel console type.
- One or two moving motors.
- Light sensing device.
- Autonomous or auxiliary energy supply.
- Light following or moving according to the calendar.
- Continuous or step-wise movement.
- Tracking all year or all year except winter.
- Orientation adjustment with/without the tilt angle adjustment.

Several methods of sun following have been surveyed and evaluated to keep the solar panels, solar concentrators, telescopes or other solar systems perpendicular to the sun beam. An ideal tracker would allow the PV cell to accurately point towards the sun, compensating for both changes in the altitude angle of the sun (throughout the day), latitudinal offset of the sun (during seasonal changes) and changes in azimuth angle. Sun-tracking systems are usually classified into two categories: passive (mechanical) and active (electrical) trackers.

5.1. Passive trackers

Passive solar trackers are based on thermal expansion of a matter (usually Freon) or on shape memory alloys. Usually this kind of tracker is composed of couple of actuators working against each other which are, by equal illumination, balanced. By differential illumination of actuators, unbalanced forces are used for orientation of the apparatus in such direction where equal illumination of actuators and balance of forces is restored. Passive solar trackers, compared to active trackers, are less complex but work in low efficiency and at low temperatures they stop working. Tests have shown that passive trackers are comparable to electrically based systems in terms of performance. Although passive trackers are often less expensive, they have not yet been widely accepted by consumers.

Clifford et al. presented a novel passive solar tracker modeled with computer. They mentioned that although the expanding metals generated deflections were small, the corresponding forces were large. Their passive solar tracker design incorporates two bimetallic strips made of aluminum and steel, positioned on a wooden frame, symmetrically on either side of a central horizontal axis. The bimetallic strips are shaded so that the strip further from the sun absorbs solar radiation while the other strip remains shaded in a similar fashion to the design illustrated in Fig. 5 [45]. To prevent oscillation or too sluggish respond, a damping system is linked to the sun tracker.

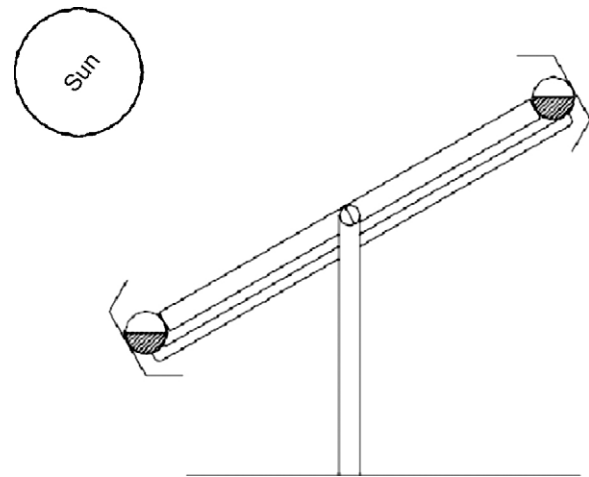

Fig. 5. A passive solar tracker using two identical cylindrical tubes filled with a fluid under partial pressure [45].

They compared the computer model and experimental results of deflections of the bimetallic strip due to the effects of thermal radiation (in mm) and time taken for the solar tracker to reorient from W–E (in s). The computer model and experimental data showed results very similar to each other. The designed solar tracker had the potential to increase solar panel efficiency by up to 23%. Finally, they recommended night return mechanism, manually tilted axis and dual axis system for future development.

Mwithiga et al. designed and constructed a dryer with limited sun-tracking capability that operated manually. The dryer consisted of a gauge 20 mild steel flat absorber plate formed into a topless box. The drying unit was bolted onto a shaft which in turn was mounted on to a stand so as to face E–W direction. A selector disc on the stand allowed the tilt angle that the drying unit made with the horizontal, to be easily adjusted in increments of at least 15°. This way, the collector plate could be intermittently adjusted in order to track the sun during the day. Four dryer settings for tracking the sun were created. The dryer was set at an angle of 60° to the horizontal facing east at 8.00 a.m. They adjusted the angle of the dryer made with the horizontal either one, three, five or nine times a day when either loaded with coffee beans or under no load conditions. The results showed that the solar dryer can be used to successfully dry grains. Drying of coffee beans could be reduced to 2–3 days as opposed to sun drying without tracking system, which takes 5–7 days and the temperature inside the chamber could reach a maximum of 70.4 °C [46].

Poulek designed and tested a single axis passive solar tracker based on shape memory alloy actuators. The actuator can easily be deformed even under 70 °C and works as a heat engine. It returns back to its original shape when heated above transformation temperature. It was concluded that the efficiency of these actuators is almost 2% and is approximately two orders of magnitude higher than that of bimetallic actuators [47].

5.2. Active trackers

Major active trackers can be categorized as microprocessor and electro-optical sensor based, PC controlled date and time based, auxiliary bifacial solar cell based and a combination of these three systems. Electro-optical solar trackers are usually composed of at least one pair of anti-parallel connected photo-resistors or PV solar cells which are, by equal intensity of illumination of both elements, electrically balanced so that there is either no or negligible control signal on a driving motor. In auxiliary bifacial solar cell, the bifacial solar cell senses and drives the system to the desired position and

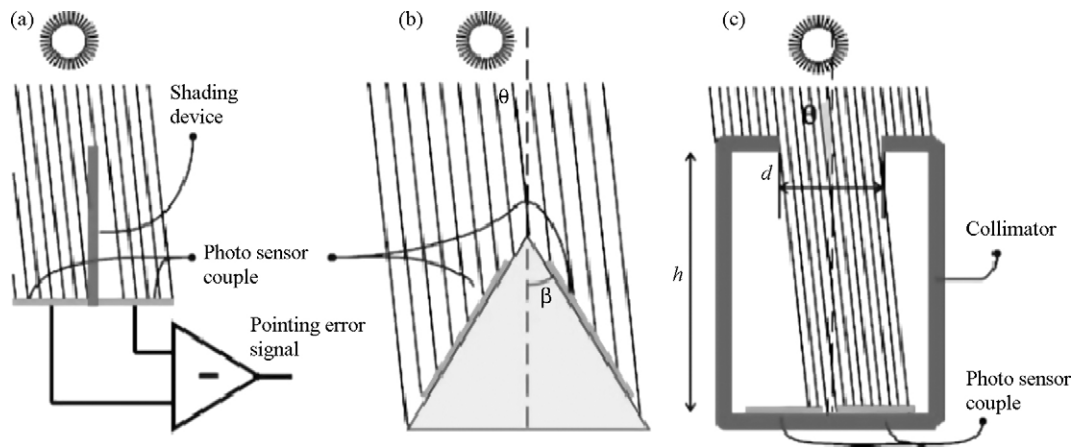

Fig. 6. Shade balancing principle (a) sun-pointing sensors (b) tilted mount of photo sensors (c) precise sun pointing by means of a collimator [48].

in PC controlled date and time based, a PC calculates the sun positions with respect to date and time with algorithms and create signals for the system control.

5.2.1. Microprocessor and electro-optical sensor based

In this type, by differential illumination of electro-optical sensors differential control signal occurs (Fig. 6a) which is used to drive the motor and to orient the apparatus in such direction where illumination of electro-optical sensors become equal and balance. In addition, the photodiodes can be mounted on tilted planes in order to increase the photocurrent sensitivity (Fig. 6b) and, very commonly in concentrator PV applications, the shading device is presented as a collimating tube which prevents diffuse irradiation from entering the sensor and masking a precise measurement of the sun alignment position (Fig. 6c) [48].

Such trackers, with high accuracy, are intended mainly for concentrator solar systems. These trackers are complex and, therefore, expensive and also unreliable.

Abdallah et al. designed and constructed a two-axes, open loop, PLC controlled sun-tracking system. Their work principle is based on mathematical definition of surface position that is defined by two angles: the slope of the surface, and azimuth angle. The slope was considered to be equal as zenith angle of the sun. Two tracking motors, one for the joint rotating about the horizontal N–S axis and the other for the joint rotating about the vertical axis were used. The daylight divided into four intervals and during each of them the solar and motors speed were defined and programmed into PLC. They predicted that the power consumption to drive motors

and control systems hardly exceeds 3% of power saved by the tracking system. Fig. 7 shows energy comparison between the tracker and the fixed surface inclined at 32°. They concluded that the use of two-axes tracking surfaces results in an increase in total daily collection of about 41.34% as compared to that of a fixed one [49,50].

Rumyantsev et al. designed and constructed a close-loop sun-tracking system for 1 kW_p solar installations. Their design of the sun-tracker was based on constructing the cheapest structural materials, such as roll-formed perforated channels and bendings, made of zinc-protected steel. Tracking mechanism was fully automatic managed by an analog sun sensor. Tracker consisted of two main moving parts: a base platform moving around vertical axis and a suspended platform with PV modules moving around horizontal axis. The base platform was equipped with three wheels one of which was connected to an azimuth drive. The suspended platform was a frame where concentrator modules were installed as three steps of a stair. Position of the suspended frame can vary in the range of ±45° symmetrically about a horizontal plane ensuring alignment of the modules in elevation. The base platform was driven by one of the wheels moving along a circle of a large radius. If motors (DC 12 V) were switched in use continuously, rotation velocity of the platforms was near to 1 rotation per hour, i.e. much faster, than it was necessary for a normal tracking. Continuous rotation of the motors was carried out for returning the trackers from “sunset” to “sunrise” position and for fast “searching” the sun, after cloudy periods. At normal tracking, the motors were switched on periodically, after each 8–10 s [51].

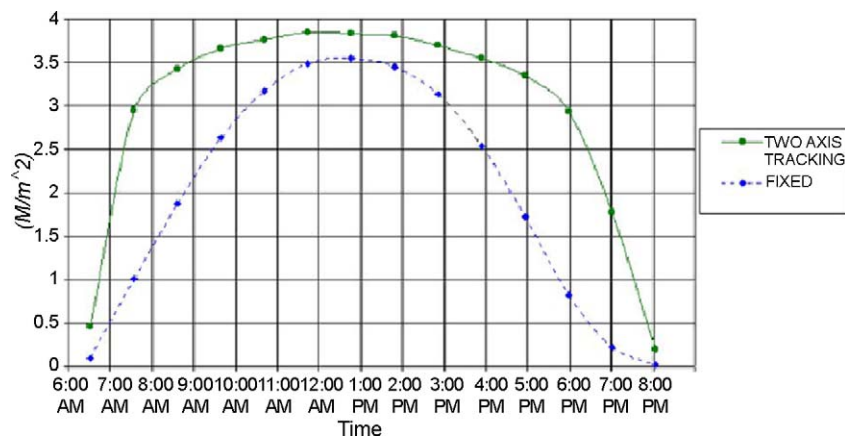

Fig. 7. Energy comparison between tracking and fixed solar system [49].

Konar et al. designed a one-axis microprocessor based sun-tracking device for using in PV flat plate solar panels or with parabolic reflectors. It was optimally tilted around one axis and controls the azimuth angle with another axis. They mentioned that this tracking device considerably saves the collected power and is independent from site circumstances such as geographical locations and temporal variation [52].

Al-Mohamad designed a single-axis sun-tracking system based on a programmable logic controlling (PLC) unit to investigate the improvement in the daily output power of a photo-voltaic module. Two photo-resistive sensors were separated by a barrier to provide shadow for one of them. As solar radiation intensity increases the resistivity of the sensor decreases. Two output signals of the unit are connected directly to the analog inputs of the PLC and compared in order to produce a proper output signal to activate an electromechanical sun-tracking system. The tracker scans through an angle of about 120° E–W. For PLC, a proper program to control, monitor and to collect data was developed using special software. A special computer program for automatic detection and PC communication with RS232 was developed using Visual Basic 5. The performance of the sun-tracker was evaluated and monitored. The output power showed a considerable increase during the early and late hours of the day. In fact, the overall improvement, in the tracking mode, exceeded 40% for the period from 6:00 to 10:00 a.m. and for the period from 15:00 to 17:00 p.m. However, the improvement was about 2–4% during mid-day. The average overall improvement during the whole day was better than 20% in comparison with that of a fixed module [53].

Abu-Khader et al. designed and constructed a PLC-controlled solar tracker system. The electromechanical system consisted of two drivers: the first for the joint rotating about the vertical axis and the second for the N–S or E–W tracking. Two bridges rectified a 220 VAC of supply network into 24 VDC to power the PLCI and into 24 VAC to supply the power for one of the electrical motors. The voltage of the second motor was 36 VDC with a worm gear while for the other motor a spur gear was used. The estimated consumed power by the electrical motor and control system was less than 3% of the collected energy by the tracking system. The PLC programming was based on the solar angles analysis divided into four intervals with corresponding motor speeds. Measurements on the PV system with and without sun-tracking showed that there was an overall increase of about 30–45% in the output power for the N–S tracking system compared to that of the fixed PV system. The optimum PV-tracking axis was the N–S that corresponded to the maximum possible power [54].

Bingol et al. proposed, implemented and tested a microcontroller based two-axis solar tracking system. They used light dependent resistors as sensors, stepper motors as actuators and a microcontroller. In addition, the system was connected to a PC via RS232 for sun position monitoring. A crystal with a frequency of 4 MHz was used as a clock signal generator for the microcontroller. The panel degree from vertical axis was fixed at 50°. The experimental study for two solar collector panels, one stationary and the other rotary were employed in the test. Temperature of the panels versus time was measured with a minute interval and 50 data were captured. The angle of intervals was almost 5.2°. A distinction of 9 °C between rotary and stationary panel was observed. This result verified that the rotary panel containing solar tracking system took more light density than the stationary panel [55].

Koyuncu et al. evaluated a two-axis microprocessor based sun-tracking system. Two limit switches to define the maximum angular positions in the east and west and limit the panel movement were linked to the microprocessor. Their test results showed that as long as the plane of the panel was kept normal to the sun the maximum collectable energy was obtained [56].

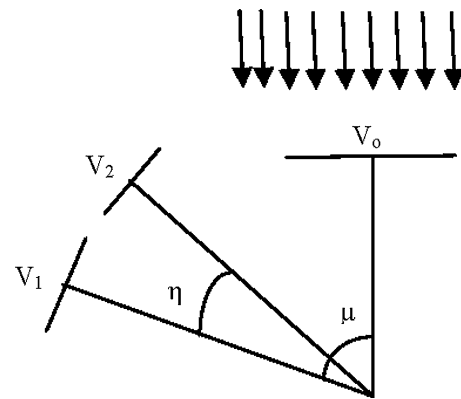

Fig. 8. Principle of Peterson et al. solar tracker system [57].

Peterson et al. designed and built a microcontroller based solar tracker that had two bipolar stepper motors to maintain a required torque and to provide 200 steps per revolution to rotate two PV panels around the altitude and azimuth axis. They evaluated three tracking algorithms to track the sun. The first algorithm drives the PV panel in a circle motion in spherical coordinates with an arbitrary radius chosen by the user to find a point on the circle for optimum voltage. The second algorithm drives the PV panel in a square pattern to find the voltage gradient, and uses that to decide where to move. The third algorithm uses the second strategy to find five points 1 h apart, then by using a multivariable, nonlinear, least-square fit, the latitude, the day of the year, the time of day, are determined. Then, the next move of the sun is predicted. Two voltages (from two PVs) are present, V_1 and V_2 that are an angle η apart and V_0 and V_1 that are an angle μ apart. V_0 is the voltage that the PV would get if it were perpendicular to the light source (Fig. 8).

Knowing V_2 , V_1 and η , one can calculate μ as follows:

$$\mu = \arctan\left(\frac{V_2 - V_1 \cos \eta}{V_1 \sin \eta}\right) \quad (3)$$

An algorithm was created and programmed into the microcontroller and was linked to an electrical board. The best sensing resolution they could really get were about 6°. They concluded that if the PV is 1 degree from perpendicular, 99.98% of the maximum possible voltage is obtained, and if it is 10° from perpendicular; 98.5% of the maximum value is accessible [57].

Girasolar company designed and constructed a programmable sun-tracker that can track the sun in two axes: azimuthal and zenithal. Its surface area was 58 m² with 2100 kg weight capable of turning with azimuthal (yaw) speed of 0.5 rpm and azimuthal movement (pitch) speed of 0.06 rpm. Maximum angle of deviation was 2° from sun position. Its structure was designed to withstand wind velocity up to 105 km/h. It has been reported that its production growth is of up to 35% over fixed installations [58].

Contreras et al. in Texas University constructed a portable solar tracker using three linked robotic arm controlled microcontrollers. Its major components were PIC microcontroller, H-bridges, DC motors, PVC custom parts, IR sensor, photo-resistor and DC outlets. The first DC motor was a 10 A, 12 V, with 500:1 gear ratio, the second motor was 75 mA, 24 V, with 3000:1 gear ratio and the third motor with 220 mA (under load), 12 V and 1000:1 gear ratio. They programmed three microcontrollers using programming language PIC Basic PRO. It was concluded that the efficiency was increased by 30% [59].

Abdallah et al. designed and constructed four electromechanical open loop solar tracking systems: a two-axis, one-axis vertical, one-axis E–W and one-axis N–S tracker, in order to estimate the current–voltage characteristics and compare to that of

a fixed one with 32° inclination to the south. The required position was calculated in advance and was programmed into PLC. The PLC controls the actuator to adjust the panel to maintain position perpendicular to the sun. They claimed that consumed power by the control system was less than 2% of the collected energy by the tracking system. After drawing several voltage–current and power generation characteristic curves for different sun trackers, they concluded that there were increases up to 43.87, 37.53, 34.43 and 15.69% of electrical power gain, respectively for the two-axis, E–W, vertical and N–S tracking, as compared to that of the fixed one [60].

Rosell et al. designed and built a PV/thermal low concentrating system and validated the developed analytical model. A two-axis sun-tracking system with two DC linear actuator and reed sensors was constructed to maximize the energy collection. In their system, mirrors reflect light onto the focal band and the solar cells are illuminated with approximately 11.1 times the solar irradiance incident beam. To obtain greater accuracy and to compute the sun position, a PLC system was designed and constructed. They quoted a 50% energy increase in comparison to that of an optimally tilted static surface [61].

Lakeou et al. designed and constructed a two-axis sun-tracking system to follow the sun in azimuth and solar direction based on a programmable logic device (an 84-pin, Xilinx XC95108). Through an H-bridge structure, a controller is connected to DC motors. Initially, once the location is selected, the azimuth elevation range is determined and the angular steps are calculated. The total number of tilt steps was 12. For monitoring the power generation, they also connected this tracking device to a PC by a code written in Assembly or C++ languages. They concluded that the proposed sun-tracker was cost effective and flexible [62,63].

Hamilton, in his thesis designed and constructed a microcontroller based sun-tracking device that used two motors to tilt the array in two planes of movement. The algorithm was designed to read and amplify sensor values and then to compare the data digitally to determine the exact position of the sun to activate the positioning uni-polar stepper motors. The sensor was a four sided pyramid in structure with solar cells mounted on each side. The microcontroller was programmed in C language. The device was tested both in the field and in the laboratory using a portable light source that was set up at 16 positions inside of a spherical area. The results showed that the sun-tracking system collected maximum energy throughout the day while stationary system collected maximum energy just when the sun was positioned overhead [64].

Zeroual et al. designed and constructed a closed loop sun-tracking microprocessor with electro-optical sensors to control a water heating solar system. Many parameters such as wind velocity, pressure and ambient temperature were also controlled. The long period tests in variable conditions, confirmed the accuracy of the system [65].

Jinayim et al. designed a highly efficient low power consumption tracking solar cells for a white LED-based lighting system. Their evaluated one-axis tracker used a stepping motor commanded by a PIC microcontroller. A photo-resistor was put in a dark box with small hole on the top. With maximum illumination detection it worked by the PIC command. If no sun light is detected by the photo resistor, the zero state actuates the system until the real state is detected. The sun energy curves and fixed and tracking panel energy curves were drawn and it was concluded that although the tracking mode was 100% efficient, the actual charge current was somewhat lower, as some power was lost due to the solar cell temperature. Finally, they recommended not using tracking system for small solar panels because of high energy losses in the stepping motor [66].

Hatfield designed, constructed and tested a microcontroller based two-axis sun-tracking device. Movement of the PV module was achieved with a 12 V linear actuator where its full course was

20 cm. A potentiometer with a voltage range of 0–5 V was used for angle measurement for a full revolution (365°) of the pot. Control of the tracker was via the light sensor and a micro controller. A DC relay was used to disconnect the load from the solar module during the open circuit voltage read by the A/D converter on the micro controller. The final results showed an efficiency increase of 27% when compared to that of a fixed panel [67].

Huang et al. designed and evaluated a one-axis tracking mechanism for adjusting the PV position only at three fixed angles (three position tracking): morning, noon and afternoon. The mechanism includes a single pole support, a tilt adjustable platform, a PV frame driven by a motor and a solar position sensor. The sun position sensor consists of two photo-sensing elements divided by a vertical shading plate. Three touch switches were mounted on the transmission gear of the frame to signal the control circuit. The PV frame stops at the touch of the next switch once it is triggered. The designated location of the switch, thus, determines the stopping angle. Many analytical studies show that the maximum solar incident radiation can be obtained if the tilted surface angle approximately equals the latitude. For each stopping angle, they calculated the yearly total energy at various switching angles of the sensor and found the maximum yearly total energy. The results showed that the optimal stopping angle was 50° , and the optimal switching angle was 25° , which was half of the stopping angle. By repeating the calculation for different solar noon tilt angles at different latitudes, it was concluded that the optimal stopping angle was about 50° regardless of the latitude, and the optimal switching angle was half of the stopping angle. It can be shown from the results of the calculated yearly total energy that the PV power generation will increase by 24.5% as compared to that of a fixed PV module [68].

Kalogirou designed and constructed a one-axis sun-tracking system consisting of a control system with three light dependent resistor sensors and a DC motor. One sensor was responsible for direct beam detection; the second was cloud sensor and the third was daylight sensor. The control system consisted of relay, timer, many resistors and electronic parts. When any of the three sensors was shaded, the motor was switched on. The system tracked the sun in E–W direction and the final rotational speed of the collector was 0.011 rpm. Various tests of the solar collector showed that the tracking mechanism was very accurate. The accuracy for 100 W m^{-2} illumination was 0.2° while for 600 W m^{-2} illumination it was reduced to 0.05° [69].

Khalifa et al. investigated the performance improvement of a two-axis sun-tracking compound parabolic concentrator. The system consisted of photo-transistors separated by a partition from one another. When two sensors are unequal, the voltage difference amplifier activates a DC motor. The system tracks the sun every three to four minutes in horizontal plane and every four to five minutes in the vertical plane (depending on the height of partition). The tracking system power consumption was 0.5 Wh. To investigate the effect of two-axis tracking on the collector performance a number of tests were carried out. During these tests, the fixed collector was oriented due south at a tilt angle of 33° . It was concluded that a two-axis tracking system may increase the energy gain of a compound parabolic concentrator collector by up to 75% [70].

Lynch et al. designed a low cost electronically controlled two-axis sun tracker. The system uses two electro-optic sensors; one of them a four-cell pyramid mounted on a tracker plane and the other was used for sun light detection. A high torque DC gearbox motor was used for drive mechanism. They addressed that the tracker can work in resolution of 0.1° that can minimize wondering on partially overcast days [71].

Aiuchi et al. developed a closed loop photo-sensor controlled heliostat using an equatorial mount. Also, two sensors were used

one for cloud cover and the other for day or night detection. The sensors consist of two side-by-side photo-cells that generate a current, which is proportional to the illuminated area. If solar radiation becomes less than 180 W/m^2 , the operation mode of the heliostat moves to the cloud mode and the frame rotates at a constant speed of $15^\circ/\text{h}$. The heliostat was placed in an S-N orientation at latitude of 35° . The solar radiation reflected by the mirrors was focused on the target screen, located 70 m on the south side of the heliostat. Their experimental and simulations showed that in a clear weather the tracking angular error of the sensor controlled heliostat was estimated to be 0.002 rad. Finally, it was concluded that the sensor system for tracking may be more suitable for a small solar system because of efficiency reduction in cloudy days [72].

Ioffe Institute PV Lab., designed a 1 kW closed loop tracker in which the turn angle can vary in the range of $\pm 70^\circ$ about horizontal and vertical planes. Continuous rotation of motors, turn the structure from sunrise to sunset. At normal operation, motors are switched on automatically every 5–8 s. Two multi-junction III–V cells are used as the light sensitive elements in the side walls and back walls of a special element namely main sensor and additional sensor. Photo-current from these cells goes to a transistor and a relay to activate motor in the desired direction [73].

Gagliano et al. designed and simulated a two-axis sun-tracking system based on a photo-resistor sensor and investigated the effects of energy gain between a fixed PV panel and a tracked one. The sensing device consisted of a nine light-dependent resistor (LDRs) for rotation, and three aligned LDRs for inclination, positioned into suitable plastic supports. It was concluded that the main advantage of the proposed tracking system was the low cost of the sensing apparatus, gained from a real time elaboration procedure on sensors data [74].

Zogbi et al. designed and constructed a low cost two-axis (elevation and azimuthally) sun-tracking system by classical electronic units. Four electro-optical sensors were placed in each quadrant formed by two rectangular planes intersecting each other in a line. The tracking control unit consists of an amplifier and other electronic parts to compare the received signals from each pair of sensors and to command two motors for device rotation. The system had an east return-and-stand by circuit to system stand at night and return eastward in the following morning. If the output from one of the sensors becomes greater than the threshold, the corresponding motor is activated by an amplifier until the error signals reduce to be less than the threshold. The corresponding time duration was 15 s. It was concluded that the constructed prototype operates successfully under variable light intensity [75].

Rumala designed and constructed a closed loop automatic sun-tracking system based on the shadow method. Photo-resistive sensors were placed on a platform under a pair of back to back mounted semi-cylinder in an E–W and N–S facing. The rigid platform had two ball jointed track arms for elevation and lateral tracking that were actuated by cam driven motors. A signal conditioning circuit of a pre-amplifier along with a low pass filter feed an amplifier to move the servomotor and to correct the differential in detected solar irradiation. The shade remains in the sunset position until the auto startup of the morning of the following day [76].

Urbano et al. assessed 5-W-peak PV module for tracking solar oven concentrator system with 2.6 kW/sub-th/capacity with 200 kg weight. The tracking system was driven by means of two 36 W, 12 V DC motors to follow the sun independently in altitude and azimuth directions. The electronic circuit commands DC motor to rotate as a function of the optical sensors for altitude and azimuth positions [77].

Palavras et al. developed a dish type solar concentration system with a two-axis sun-tracking mechanism. The aperture diameter of

the dish was 2.85 m and its focal length was 1.02 m. The sun-tracking mechanism had an electronic circuit that processed the signals from a set of photo-resistor sensors and output signals to the relays to actuate the dish with a circuit power supply of 5 V. When the sensors are unbalanced their resistance will differ and the relay will power a 24V heavy duty DC dish actuator. Measurements showed an average value of overall heat loss coefficient of approximately $163 \text{ W/m}^2 \text{ K}$ and in the focal point region the temperature reached above 300°C [78].

Abouzeid constructed an active tracking system by two opposite position-sensing cells and a reluctance four phase stepper motor with 7.5° per step with a controlled power via a programmable logic array (PLA) chip. The sequence of switches inside the power converter is arranged so that the step motor is self-breaking. Once the solar incident is diverted from perpendicular to the major surface, two sensing cells become unbalanced and send error signals to the chip and then the phase of the step motor is assigned. The circuit configuration is programmed using XILINX software, and then downloaded to an EEPROM. This system can work in steps of either 15° or 7.5° and can stand alone without any supervision [79].

5.2.2. Auxiliary bifacial solar cell based

Auxiliary solar cells (panels) connected directly to a permanent magnet DC motor are fixed to a rotary axle of the tracker and can both sense and provide energy for tracking.

Poulek et al. described a very simple, reliable solar tracker for space and terrestrial applications. Unreliable and expensive components like batteries and driving electronics were completely eliminated (Fig. 9). It works also at low temperatures down to -40°C . The area of the auxiliary solar panel of the tracker is about 1% of the total area of moved solar arrays. Their auxiliary bifacial solar cell together with bifacial solar arrays enables backtracking from any position (360° tracking angle) while trackers based on similar technology with standard mono-facial solar cells have a tracking/backtracking angle of 120° .

They concluded that the tracker follows the sun with deviation of $\pm 5^\circ$ without any reduction in the collected energy. The system collected more than 95% of the energy of an ideal tracker [80].

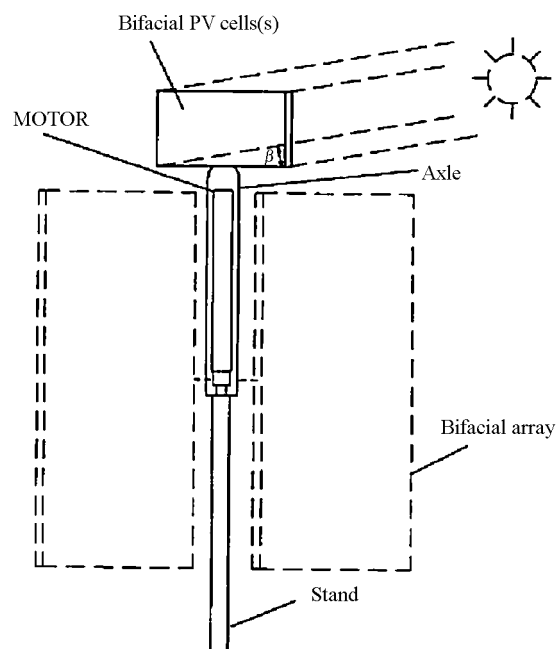

Fig. 9. Scheme of the terrestrial tracker [80].

In another work they designed and constructed a solar tracking system based on an auxiliary bifacial solar cell capable of backtracking within 5 min and average tracking accuracy of $\pm 5^\circ$ to be installed above a V-trough concentrator with bifacial solar panel. Two anti-parallel arrangements of solar cells with 1% of the area of the moved solar collectors were connected directly to a reversible DC motor with a self-locking transmission. In a cloudy condition, once the sun starts shining, collectors will start moving. Their experimental result shows that the bifacial PV modules with reduced temperature sensitivity can boost energy gain by 15–25% in comparison with the same tracker/concentrator with mono-facial modules. The polar axis solar tracker with C–Si bifacial PV modules will therefore deliver about 50% more energy than that of a fixed C–Si mono-facial PV array with the same rated output power. The tracking bifacial soft concentrators even double the energy gain against a fixed mono-facial PV array [5].

Karimov et al. constructed a one-axis PV tracker system with four solar modules installed on a rotor; its other axis was manually adjustable in order to fix the inclination angle of modules at 23° , 34° and 45° . Solar modules were divided into two pairs and the angle between the modules of a pair was 170° . Main modules was used both for the sensing and energy conversion purposes (Fig. 10).

The modules were connected to bridge circuit very similar to the Wheatstone bridge. If the output voltage from modules is not equal, the voltage applied to the DC motor is not zero and as a result, the motor starts turning. Their research shows for tracking system, unlike the fixed modules, the voltage output in the evening and morning are not very different and the tracking mode collects 30% more energy [81].

Poulek et al. designed a solar tracker based on a new arrangement of solar cells connected directly to a reversible DC motor. Like their previous work, solar cells, both sense and provide energy for tracking. Fig. 11 shows the principle of the tracker.

Sensing/driving solar cells are balanced to each other. Differential signal is used to overcome friction and aerodynamic drag. The rotary axle of the tracker was oriented in the N–S direction with accuracy of about $\pm 10\%$. The area of the auxiliary solar panel of the tracker is about 2% of the area of the moved solar collectors while collectable energy surplus is up to 40% [82].

5.2.3. Date and time based

In the date/time mode, the computer or a processor calculates the sun's position from formulae or algorithms using its time/date and geographical information to send signals to the electromotor.

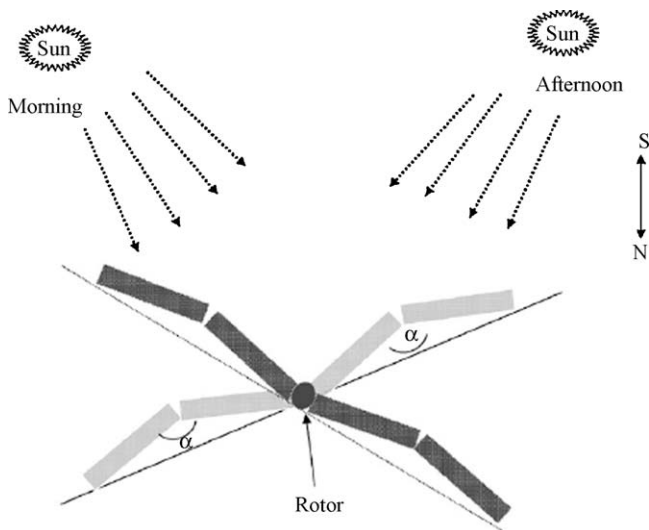

Fig. 10. Position of PV modules in the morning and afternoon [81].

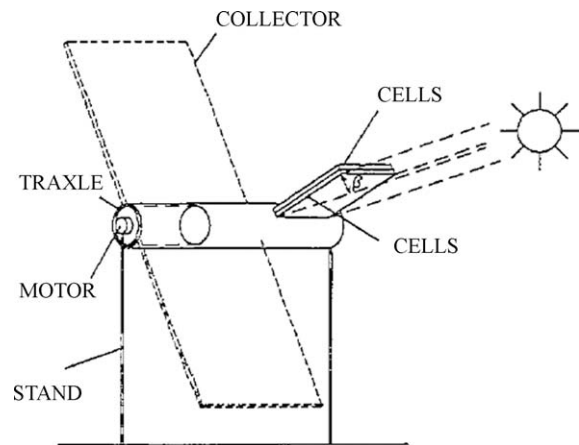

Fig. 11. Horizontal axis tracker [82].

However, in some cases many sensors are used to identify specific positions.

Canada et al. designed and constructed a sun-tracker with a maximum positional error of 2° , for the measurement of global and direct spectral solar irradiance in the 330–1100 nm range. They designed a sun-tracker according to their specific needs and for a relatively low cost allowing up to 1 week work without the need for any operator supervision and returning each night to a rest position avoiding turning back over itself. The movement of the whole system is commanded by a step motor and gear speed reducer to adjust the step required. The system had 2° of freedom, one rotation in the azimuth plane over a fixed base, and the other rotation in the principal solar plane. The pass motor control is carried out by a control board that was specially designed for this type of motor, including a compatible interface that is connected to the parallel port of the PC through optical couplers. This configuration was to give the system a reference point from which to correctly position itself. Two on/off sensors indicating the initial position for each of the degrees of freedom were used. These are optical pass detectors made of an LED and a photo-detector working in the infrared zone. To cutout the sensors at the desired position, fixed aluminum reference points are used to identify the geographic north and the zero solar elevation.

All codes were written in C++ Builder under Windows environment to: (a) provide movement relative to the sun, (b) control motor, (c) adjust and return to the rest position, and (d) alarm and activate/deactivate sensors. From these data, by using a subtractive method, the diffuse irradiance on a horizontal plane is calculated. Finally, using the Bouguer–Lambert–Beer law, the algorithm calculates total atmospheric thickness and aerosol optical depth in the 330–1100 nm range [83].

Edwards examined the operation of a computer based sun following system for parabolic collectors. The computer of the system changes the speed of each of the collector actuators at regular intervals over the day. It is shown that for accurate sun following, the system requires a data output from the central controller of only 500 bit/s for 10,000 collectors [84].

Alata et al. designed and simulated a time controlled step sun-tracking systems that include: one-axis sun-tracking with the tilted aperture equal to the latitude angle, equatorial two-axis sun-tracking and azimuth/elevation sun-tracking (Fig. 12). A comparison study was made based on fuzzy decision making method among these three sun trackers.

The one-axis tracking system was tilted from the horizontal equal to the latitude angle pointing due south ($\beta = 32^\circ$). The hourly variation of declination angle is considered very slow; hence, the tracking at this axis can be adjusted once or a few times during the

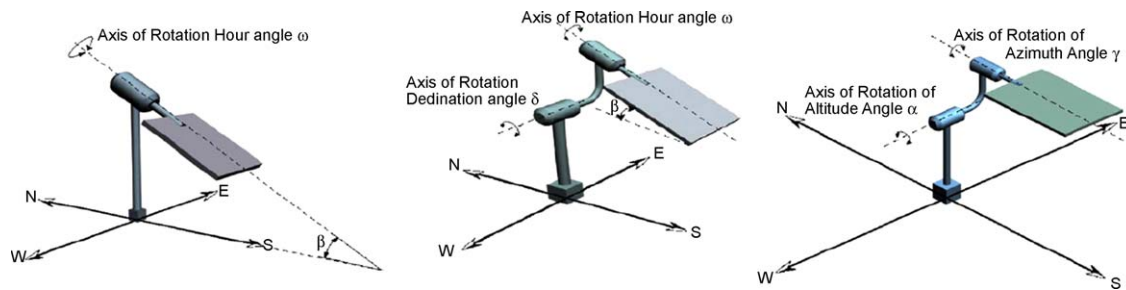

Fig. 12. (From left to right) One-axis sun-tracking system with tilt angle equal to the latitude angle; two-axis equatorial sun-tracking system with tilt angle equal to latitude angle; two-axis azimuth/elevation sun-tracking system [85].

day for a two-axis equatorial sun-tracking system with tilt angle equal to the latitude angle. The design of the azimuth/elevation tracking includes one-axis rotating about the zenith axis (perpendicular axis) while the other axis is parallel to the surface of the earth.

In the Alata et al. work, the formulation of equations that describe the sun motion in the sky and the design of three types of multi-purpose sun-tracking systems are introduced. The formulation is a replacement of the mathematical equations of altitude, azimuth, declination and hour angles by fuzzy IF–THEN rules using subtractive clustering along with ANFIS as a rule extraction method. Then, a 3D simulation of various sun-tracker types, driven by a DC motor for each axis of tracking, is demonstrated throughout a virtual reality (VR) mode. Each output of the fuzzy inference system is related directly to two inputs: the day number during the year and the time of the day in hours. The results are shown using simulation and in VR mode [85].

Aliman et al. developed a new sun-tracker to gain high concentration solar energy. Their system consists of a master mirror surrounded by several slave mirrors. The master mirror reflects sun beams to a stationary target. Sun image in this target acts as a reference for all slave mirrors. The sun-tracker had two tracking axes perpendicular to each other. One is the rotational axis pointing toward the target; the other is the elevation axis parallel to the reflector. As the sun moves through the sky from the morning to solar noon, the mirror plane will rotate starting from horizontal and turning to vertical. The angular movement about this rotation axis is denoted as ρ . They derived a formula based on time and date for ρ to represent an elevation/rotation tracking mode which was proved to be successful [86].

Nuwayhid et al. presented a simple exercise in designing, building and testing a PC connected two-axis solar tracker concentrator. They predicted the solar position by using solar altitude and the solar azimuth angles which in turn vary in sinusoidal form and both functions of time. Each axis was connected to a DC motor and each motor had a relay to count certain number per revolution. The angle-per-counts relation was determined from experimental data. When the speed of the hour angle motor is reduced to 0.23 rpm, an installed gear box increases the speed to 23 rpm. The motors and their position sensors were connected to a PC. The PC computes solar time and solar angle at a given site. The system uses a temperature sensor and also nine LDR sensors in a tube to define sun image. It was concluded that tracking increases the working fluid's temperature in the range of 200–600 °C in comparison to that of un-tracking that operates in the range of 80–200 °C. But simple design and low cost of the un-tracking systems are attractive options to be overlooked easily [87].

AL-Jumaily et al. studied the performance of a flat linear Fresnel lens concentrating solar radiation on two absorbers connected in series. It was manufactured in such a way to track the sun in two dimensions (the altitude and azimuth angles). More than 200 tests were carried out to evaluate the thermal and optical efficiencies

versus hour angle and fluid inlet and outlet temperatures. They found that due to use of two dimensional sun-trackers that keep the incident flux always perpendicular to the collector, the optical efficiency maintained constant thorough the day (about 64%) [88].

Abdallah et al. developed a 1 m² single axis sun-tracking solar still with PLC control. In this design a motor turns the structure about vertical axis (azimuth tracking). The power consumption by motor and electric system was estimated to be 3% of the collected energy. Day hours were divided in four intervals and the motor speed was programmed into PLC in each interval. Graphical results showed an increase of up to 40% in the morning till mid-day and up to 22% in the evening for tracking mode [89].

Davies designed a sun-tracking mechanism using equatorial and ecliptic axes that intersect each other in 23°30'. In this design the sun was considered as a fixed point relative to the earth's motion, therefore, the tracking plate must rotate about earth's orbit and spin at the same angular velocity of the earth but in the opposite direction. A triangular module is pivoted by a ball joint allowing free rotation. The tracking error was predicted to be about $\pm 2^\circ$. The main advantage of this system is the use of an accurately constant speed motor without any complicated control electronics [90].

Khlaichom et al. applied a closed loop control using genetic algorithm (GA) method for a two-axis (altitude over azimuth) solar tracking system. A sensor fabricated from poly crystalline solar cell converts solar radiation to voltage. In their algorithm the decoder and counter receive signals from an optical encoder and convert it to the current corresponding to degree-position of the axle turns. Data is then transferred to a PC via an interface card for maximum tracking. The system tracks the sun with $\pm 10^\circ$ in both axes. The tests and analyses explained that the solar tracking system using GA increases the output voltage to 7.084% in comparison to that with no GA [3].

Blanco et al. compared the differences in proposed algorithms for determination of the sun position. They mentioned that even for the four complete algorithms (the one proposed by Michalsky being the most accurate) their accuracy, computing efficiency, and ease of use can still be improved. As a result, a new algorithm called the PSA algorithm was developed. They evaluated an open-loop microprocessor based and found it to be more accurate, low cost and simpler algorithm controller that computes the direction of the solar vector based on geographical location and time. Compared to Michalsky algorithms, PSA algorithm showed lower standard deviation of error of 22, 14 and 28% in true zenith angle, azimuth and direction vector of the sun, respectively. Likewise, the range of the errors in computing the true zenith distance, azimuth and direction vector of the sun was found to be 24, 8 and 35% lower than that of the Michalsky algorithm [91].

Koyuncu et al. evaluated a microprocessor based sun-tracking system to control the movement of a solar panel. To limit panel movement, the maximum positions at east and west were limited using two limit switches. The status of the limit switches is read by the microprocessor. They concluded that using tracking device to

keep panels perpendicular to solar direction maximizes the thermal energy obtained from the solar panels [92].

5.2.4. Combination of sensor and date/time based

Roth et al. designed and constructed a two-axis (one axis from east to west and the other for elevation) sun following device. They used a pyr heliometer as a measuring instrument to follow the sun, potentiometers and the limit switches coupled to the motion axes (one to each axis) to send signal to the CPU proportional to the axes movement, microprocessor of the series 16F877 as a main part connected to a PC and two sensors, one for sun position information and the other for indicating the intensity of the sun radiation, signaling the beginning and end of the day. During the clock mode, the tracker computes the position of the sun based on the date/time information of its clock. Light position errors are measured during the day and stored for later analysis. The data gathered during the day are analyzed, and a new improved set of parameters for the installation errors is computed. These data are used in the next day to compute more accurate positions of the sun. In the sun mode, the tracker uses the data of the sun position to control the pointing actively. If the intensity drops below a certain level, it falls temporarily back to the clock mode. For solar radiation below 140 W/m^2 the registration falls suddenly to zero, but above this value the system works under a stable condition. For preparation and testing, an Eppley pyr heliometer was mounted on the support of the sun-tracker. To make the measurements more precise and to compare the measured irradiance with Eppley pyr heliometer at the tested tracker, three additional pyr heliometers were used, two of them were of Eppley pyr heliometers at the INTRA sun-tracker and the other with Kipp and Zonen pyr heliometer. The experiments showed good results comparable to that of the Swiss sun-tracker INTRA but at a very much lower price (75 times more cheaper than Swiss tracker) [6,93].

Ajay et al. designed a one-axis sun-tracker, based on a microcontroller and time controlled techniques, to be installed on a line focused solar parabolic trough concentrating collector. A wind velocity sensor, an irradiation sensor and a temperature sensor were connected to an ADC port of a microcontroller communicating with a Real Time Clock (RTC). The processor manipulates data received from sensors and data from RTC to calculate the sun position and sends signals to a motor. The height of the shadow at the top of the light sensors was 86 mm resulting in 1° of resolution. The resolution also is dependent on the solar radiation intensity. In low intensities, only the time control system operates. When the signal from any of the light dependent resistors crosses the reference voltage, the comparator output becomes low. This is the cause of the error signal for collector movement. The pulses from the motor rotation sensor

are interfaced to the controller. An algorithm is developed such that, several features in the software will make the system reliable. The controller performance under different environmental circumstances such as sunny days, cloudy days, hazy conditions, etc., shows that the sun sensor assembly was very sensitive in detecting small changes in the sun position and was tracking the sun and aligning the collector surface to receive the sun rays within 1° from its normal [94].

Rubio et al. discussed the design and implementation of a two-axis PV sun-tracker using a combination of an open loop tracking strategy with a microprocessor in which the controller is based on a solar movement model, and a closed loop strategy which corresponds to the electro-optical controller. The instantaneous power generated by the arrays is measured by a sensor that emits a signal proportional to this power. Finally, they implemented a proportional and integral (PI) control strategy for each coordinate, independently. Their tracking strategy produced a close approximation of the evolution of the sun's elevation and azimuth even if the solar equations yield quite large errors. Fig. 13 shows a simulated example of the evolution of the three variables (the sun's real movement (SMv), the progression of the values yielded by the solar equations (SEq) and the evolution obtained after the corrections (CEq). They concluded that the electric power generated using the hybrid strategy is, in mean values, 55% higher than that of the open loop one [95].

Bakos designed and constructed a two-axis sun-tracking system which is based on the combination of the conventional photo-resistors and the programming method of control. The electromechanical device consists of four relays, two electronic circuits, two photo-resistors connected in series and two AC motors. For manual operation, drawing a graphical representation and defining sunrise and sunset times, for the system connected to a computer a code is written in Visual C++ programming language. The system can track the sun in E-W and N-S direction. It was concluded that the two-axis tracking system is up to 46.46% more efficient in comparison to that of the fixed surface tilted 40° from the south [96].

Hession et al. assessed an electromechanical one-axis (E-W) sun-tracker using several photo-transistors to control collector-dish positions. The difference signals from the photo-resistors were converted to voltage and were amplified to drive a 2.2 W DC motor. From nine photo-transistors in the sensor, one was used for night and day detection, six for wide angle sensing and two for very narrow angle sensing. A desired resolution was 0.1° . To obtain precise energy measurements, the system used a clock type driven mechanism under cloudy conditions [97].

Luque-Heredia et al. evaluated a novel PI based hybrid constant speed sun-tracking algorithm for PV concentration. Their desired

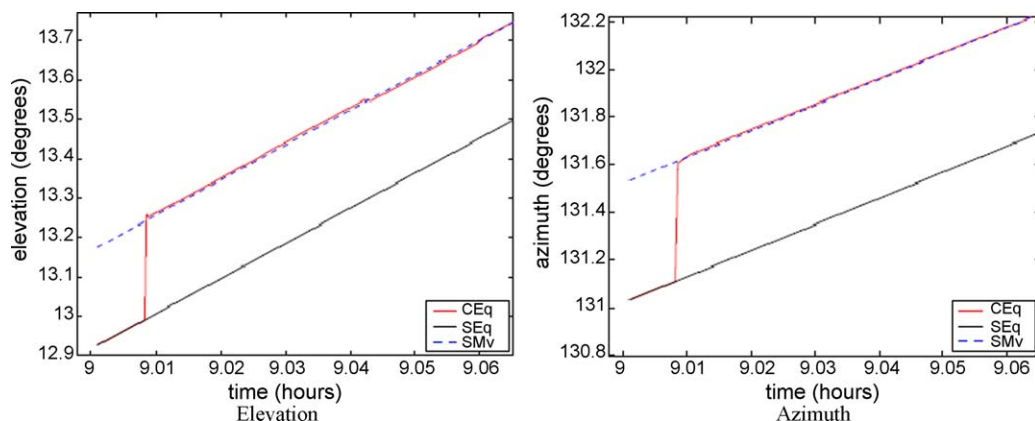

Fig. 13. Evaluation of the coordinates [95].

Table 1
Energy gain for different trackers.

Tracker type	Second axis	Tracking method	Evaluation way	Location latitude	Compared to	Gain	Reference
Two-axis			Theoretical		Fixed	57%	[5]
Two-axis			Generally		Fixed	0–100% daily 30–40% yearly	[7]
One-axis tracker	Tilted with two-positional		Computer simulation		Fixed	10–20% seasonal	[8]
One-axis tracker azimuthal	Tilted three positional				Horizontal plane	72% yearly	[11]
Optimally tilted	Fixed				Horizontal plane	30.2% yearly	[11]
One-axis tracker azimuthal (vertical)	Tilted three positional				Hour angle three steep	0%	[11]
Variable azimuth	Fixed slope		Experimentally and computer simulation		Fixed to a slope of 40°	9.9% yearly	[12]
Seasonal tracking	Fixed slope		Experimentally and computer simulation		Fixed to a slope of 40°	2.4% yearly	[12]
Variable azimuth	Fixed slope		Experimentally and computer simulation		Seasonal tracking	7.4% yearly	[12]
Two-axis	–		Experimentally and theoretically		Horizontal	30–40%	[18]
Two axis azimuth/elevation tracker	–		Experimentally		Tilted 40° horizontally	30% yearly	[19]
Azimuth (vertical) axis	Horizontal		Experimentally		Tilted 40° horizontally	18% yearly	[19]
N–S tracker	6° tilted		Experimentally		Tilted 40° horizontally	11% yearly	[19]
Two-axis	–		Actual		36° tilted	37.7% yearly	[21]
Two-axis	–		Actual		30° tilted fixed	30.4% yearly	[21]
Two-axis	–		Simulation		30° tilted	31.5 yearly	[21]
Two-axis	–		Actual		Horizontal	23%	[24]
Two-axis	–		Actual		Tilted south fixed	22–33%	[25]
Two-axis	–		Simulation		N–S axis tracker	10% yearly	[26]
Two-axis	–		Simulation		Polar axis (N–S axis tracker with south tilt)	3% yearly	[26]
Two-axis			Experimental		40° tilted fixed	38% yearly	[27]
One-axis (N–S axis)			Experimental		40° tilted fixed	34% yearly	[27]
Two-axis			Theoretical		40° tilted fixed	54%	[27]
Tilted at $\varphi - 5$ fixed	Fix		Theoretical		Horizontal	10% yearly	[29]
Horizontal N–S axis	Fix		Theoretical		Horizontal E–W axis	15% yearly	[29]
Polar axis tracker	Tilted south		Theoretical		Horizontal N–S axis	10% yearly	[29]
Two-axis	–		Theoretical		Polar axis tracker	A few % yearly	[29]
Two-axis	–		Theoretical		Polar axis tracker	0%	[33]
Two-axis	–		Theoretical		Horizontal N–S axis	26.2% yearly	[33]
Two-axis	–		Theoretical		Horizontal E–W axis	10.9 yearly	[33]
One-axis	South faced		Actual		Tilted south fixed	20% yearly	[37]
Two-axis			Theoretical	23.3°	Horizontal	7% yearly	[40]
Two-axis			Theoretical	47.7°	Horizontal surface	21% yearly	[40]
Polar tracking (variable azimuth)	Fixed slope		Theoretical	23.3°	Horizontal surface	15.9% yearly	[40]
Azimuth tracking	Horizontal		Theoretical	23.3°	Horizontal surface	13.1% yearly	[40]
E–W tracking	N–S horizontal	Constant rotational tracking speed	Theoretical	23.3°	Horizontal surface	13% yearly	[40]
N–S tracking	E–W horizontal axis	Maximum beam irradiance	Theoretical	23.3°	Horizontal surface	8.3% yearly	[40]
Two-axis	–		Actual		Tilted south fixed	40% yearly	[43]
Two-axis	–	Electro-optical sensor	Experimental	32°	Fixed tilted 32°	41.34% yearly	[49,50]
E–W tracker	Fixed sloped	Electro-optical sensor	Experimental		Tilted fixed	20% yearly	[53]
N–S tracking	Fixed sloped	Electro-optical sensor	Experimental		Tilted fixed	30–45% yearly	[54]

Two axis (azimuthal and zenithal)	Electro-optical sensor	Experimental	-	Tilted fixed	35% yearly	[58]
Two axis (portable)	Electro-optical sensor	Experimental	-	Tilted fixed	30%	[59]
Two axes	Electro-optical sensor	Experimental	32°	Tilted fixed	43.87% yearly	[60]
Azimuth (vertical) tracker	Electro-optical sensor	Experimental	32°	Tilted fixed	34.43%	[60]
E-W tracker	Electro-optical sensor	Experimental	32°	Tilted fixed	37.53%	[60]
N-S tracker	Electro-optical sensor	Experimental	32°	Tilted fixed	15.69%	[60]
Two-axis	Electro-optical sensor	Experimental	-	Tilted fixed	27%	[67]
One-axis three position tracker	Electro-optical sensor	Experimental	-	Tilted fixed	24.5% yearly	[60]
One-axis E-W tracker	Auxiliary bifacial solar cell	Experimental	-	Full tracking	-5%	[80]
One-axis E-W tracker	Auxiliary bifacial solar cell	Experimental	-	Tilted fixed	30%	[81]
E-W tracker	Auxiliary bifacial solar cell	Experimental	-	Tilted fixed	40%	[82]
Azimuth tracking	Date/time	Experimental	-	Tilted fixed	31%	[89]
Two-axis (altitude/azimuth)	Date/time with GA	Experimental	-	Tilted fixed	7.084%	[3]
Two-axis	Combination of sensor and date/time base	Experimental	-	Fixed tilted 40°	46.46%	[96]

tracker combines both open-loop ephemeris computing and closed loop sun pointing sensor based controllers. For feed forward open-loop estimation of the sun's position a mathematical model was used as a function of time, geographical coordinates and a set of disturbances. To increase the tracking accuracy, a feedback loop derived from the disturbances in the process' model was introduced. They plotted the curve of real sun positions, the curve of sun equation and corrected sun equation versus time. Results showed that the real sun positions and the curve of corrected sun equation correspond to each other after 1 h [98].

Georgiev et al. constructed an "altitude over azimuth" mode sun-tracker in which one axis of the tracker was mounted vertically to track the sun with resolution of 0.05°. They used a brushless motor on each of two axes and a worm drive gear for transmission. The connection to a PC was provided with a selectable RS232-C, RS422 or RS485 serial port. Their follower worked in three modes: the clock mode using date/time information, the sun mode using the signal of the sun position to control actively the pointing, the remote mode where primary and secondary positions are set by commands. Also, one mode called monitor mode, is used to configure the non-operational case. Measurements were conducted automatically with three pyrhelimeters and manually with one pyrhelimeter. Then, data from pyrhelimeters were fed to an ADC card, stored in a computer. With output voltage of the pyrhelimeter, and an experimental formula, they calculated the irradiance. In good conditions, a 60 W/m² difference between radiations measured with different pyrhelimeters, showed successful future measurements with this installation [99].

Durisch et al. developed and tested a single cells and modules with sun tracker PC-based, in order to provide outdoor data under real operation conditions for optimum utilization of PV power. In their design, daily sun's declination was taken into account by a specially developed crank mechanism. A simple open-loop control provided precise tracking for both polar and declination axes, via step motors and worm gears. To measure insolation incident on the cells and modules, six pyranometers were connected in series and a reference cell was mounted on the tracker. Several measurements such as ambient and module surface temperature, direct normal irradiance, wind speed, voltage and current sensors were taken into account. The collected data were sent to a PC and the voltage-current and power-voltage curves were drawn. Their tests revealed that the difference in the highest power obtained via two methods: one from searching highest power during voltage-current scans and second found by mathematical methods, was less than 0.02% [100].

Saxena et al. designed and fabricated a two-axis microprocessor based controller for sun-tracking that follows the sun in azimuth and altitude directions by two step motors. The system acts in both closed-loop and open-loop modes. Their system consisted of data acquisition and storage facility, battery control facility, system monitoring, RAM, converter card, microprocessor card, and sensor card for wind, cloud, altitude reverse, altitude forward, azimuth reverse, azimuth forward detection. In the closed-loop mode, the tracker starts at about 5 a.m. and moves under CLOUD mode till the sun is out. In the evening, further forward motion stops. The tracker is brought back to HOME position in the night. The data for the PV parameters and meteorological parameters are acquired every 10 min [101].

6. Conclusion

The energy gain from different tracking devices reviewed in this article is categorized in Table 1.

Taking into consideration all reviewed articles, sun trackers are categorized solely in one-axis or two-axis devices. However, the

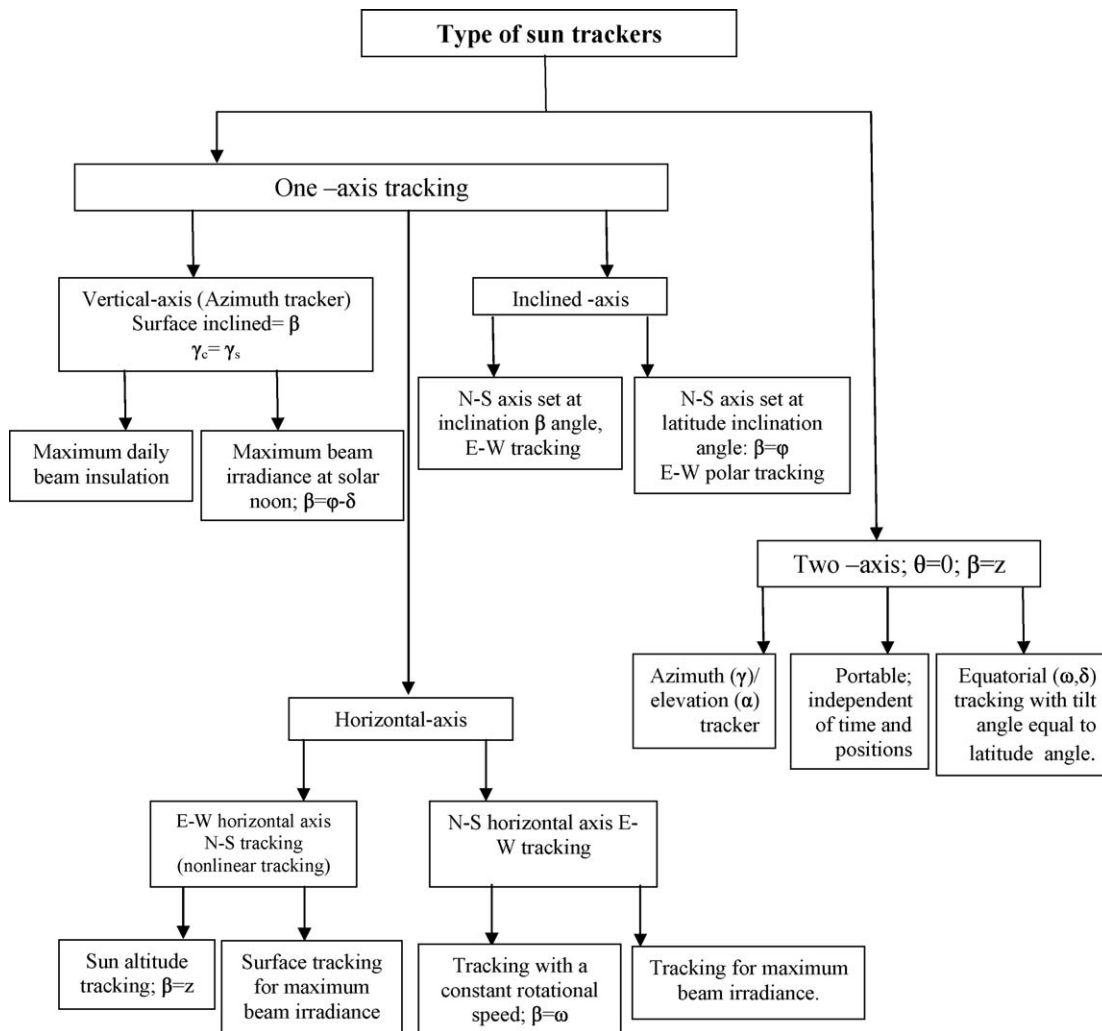

Fig. 14. Types of sun trackers.

tracking surfaces including passive or active trackers may also be classified as in Fig. 14.

References

- [1] California Institute of Technology. Basic research needs for solar energy utilization. Report of the basic energy sciences workshop on solar energy utilization; April 18–21, 2005.
- [2] Markvart T. Solar electricity, 2nd ed., New York: John Wiley and Sons Inc.; 1996.
- [3] Khlaichom P, Sonthipermoon K. Optimization of solar tracking system based on genetic algorithms; 2006. <http://www.thaiscience.info/>.
- [4] Walraven R. calculating the position of the sun. Solar Energy 1977;20:393–7.
- [5] Poulek V, Libra M. New bifacial solar trackers and tracking concentrators; 2007. <http://www.solar-trackers.com>.
- [6] Roth P, Georgiev A, Boudinov H. Cheap two-axis sun following device. Energy Conversion and Management 2005;46:1179–92.
- [7] Tracstar. Should you install a solar tracker?; 2007. <http://www.helmholz.us/smallpowersystems/>.
- [8] Bione J, Vilela OC, Fraidenraich N. Comparison of the performance of PV water pumping systems driven by fixed, tracking and V-trough generators. Solar Energy 2004;76:703–11.
- [9] Tomson T. Discrete two-positional tracking of solar collectors. Renewable Energy 2008;33:400–5.
- [10] Agee JT, Obok-Opok A, Lazzar MD. Solar tracker technologies: market trends and field applications. Advanced Materials Research 2007;18–19:339–44.
- [11] Ai B, Shen H, Ban Q, Ji B, Liao X. Calculation of the hourly and daily radiation incident on three step tracking planes. Energy Conversion and Management 2003;44:1999–2011.
- [12] Michaelides IM, Kalogirou SA, Chrysis I, Roditis G, Hadjiyianni A, Kambezidis HD, et al. Comparison of performance and cost effectiveness of solar water heaters at different collector tracking modes in Cyprus and Greece. Energy Conversion and Management 1999;40:1287–303.
- [13] Grass C, Schoelkopf W, Staudacher L, Hacker Z. Comparison of the optics of non-tracking and novel types of tracking solar thermal collectors for process heat applications up to 300 °C. Solar Energy 2004;76:207–15.
- [14] Helwa NH, Bahgat ABC, Shafee AMRE, Shenawy ETE. Computation of the solar energy captured by different solar tracking systems. Energy Sources 2000;22:35–44.
- [15] Lorenzo E, Perez M, Ezepeleta A, Acedo J. Design of tracking photovoltaic systems with a single vertical axis. Progress in PV Research and Applications 2002;10:533–43.
- [16] Mumba J. Development of a photovoltaic powered forced circulation grain dryer for use in the tropics. Renewable Energy 1995;6(7):855–62.
- [17] Sangani CS, Solanki CS. Experimental evaluation of V-trough (2 suns) PV concentrator system using commercial PV modules. Solar Energy Materials & Solar Cells 2007;91:453–9.
- [18] Pavel YV, Gonzalez HJ, Vorobiev YV. Optimization of the solar energy collection in tracking and non-tracking PV solar system. In: Proceedings of the 1st international conference on electrical and electronics engineering, ICEEE; 2004. p. 310–4.
- [19] Helwa NH, Bahgat ABC, Shafee AMRE, Shenawy ETE. Maximum collectable solar energy by different solar tracking systems. Energy Sources 2000;22:23–4.
- [20] Oladiran MT. Mean global radiation captured by inclined collectors at various surface azimuth angles in Nigeria. Applied Energy 1995;52:317–30.
- [21] Chicco G, Schlabbach J, Spertino F. Performance of grid-connected photovoltaic systems in fixed and sun-tracking configurations; 2007. <http://www.labplan.ufsc.br/congressos/PowerTech07/>.
- [22] Ibrahim SMA. The forced circulation performance of a sun tracking parabolic concentrator collector. WFEC; 1996. <http://cat.inist.fr/>.
- [23] Brunotte M, Goetzberger A, Blieske U. Two-stage concentrator permitting concentration factors up to 300× with one-axis tracking. Solar Energy 1996;56(3):285–300.

- [24] Shaltout MAM, Ghttas A, Sabry M. V-trough concentrator on a PV full tracking system in a hot desert climate. *Renewable Energy* 1995;6(5–6):527–32.
- [25] Baltas P, Tortorelli M, Russell PE. Evaluation of power output for fixed and step tracking PV arrays. *Solar Energy* 1986;37(20):147–63.
- [26] Gordon JM, Wenger HJ. Central station solar PV system: field layout, tracker, and array geometry sensitivity studies. *Solar Energy* 1991;46(4):211–7.
- [27] Nann S. Potential for tracking PV systems and V-troughs in moderate climates. *Solar Energy* 1990;45(6):385–93.
- [28] Braun JE, Mitchell JC. Solar geometry for fixed and tracking surfaces. *Solar Energy* 1983;31(5):439–44.
- [29] Dickinson WC. Annual available radiation for fixed and tracking collectors. *Solar Energy* 1978;21:249–51.
- [30] Neville RC. Solar energy collector orientation and tracking mode. *Solar Energy* 1978;20:7–11.
- [31] Felske JD. The effect of off-south orientation on the performance of flat-plate solar collectors. *Solar Energy* 1978;20:29–36.
- [32] Matthew CD, Wettergreen D, Villa D. In: A sun-tracker for planetary analog rovers. i-SAIRAS 2005—the 8th international symposium on artificial intelligence robotics and automation in space; 2005.
- [33] Kalogirou SA. Solar thermal collectors and applications. *Progress in Energy and Combustion Science* 2004;30:231–95.
- [34] Grena R. An algorithm for the computation of the solar position. *Solar Energy* 2008;82:462–70.
- [35] Comsit M, Visa I. Design of the linkage type tracking mechanisms of the solar energy conversion systems by using multi body systems method. In: The 12th IFTOMM world congress; 2007.
- [36] Splitt ME, Bahrmann CP. Detection of SIRS solar tracking problems with automated algorithms. In: The 9th ARM science team meeting; 1999.
- [37] Stern M, Duran G, Fourer G, Mackamul K, Whalen W, Loo MV, et al. Development of a low-cost integrated 20-kW-AC solar tracking sub-array for grid-connected PV power system applications. Final technical report. NREL/STR-520-2475 9. National Renewable Energy Laboratory, A National Laboratory of the U.S. Department of Energy Managed by Midwest Research Institute for the U.S. Department of Energy; June 1998.
- [38] Naidoo P, Niekerk TIV, Brooks M. Intelligent control and tracking of a parabolic trough solar collector. First African Control Congress, University of Cape Town, Cape Town; 2003.
- [39] Stolfi F, Bersohn D, McIver B, Shaw S, Vance N, Wang X. Solar concentrating and tracking apparatus. Final report. Columbia University, Department of Mechanical Engineering; May 2, 2007.
- [40] Appelbaum J, Flood DJ, Crutchik M. Solar radiation on mars: tracking photovoltaic array. NASA Technical Memorandum 106700; September 1994.
- [41] Nafeh AESA. Evaluation of the optimum tilts of a PV array using maximum global insolation technique. *International Journal of Numerical Modeling Electronic Networks Devices and Fields* 2004;17:385–95.
- [42] Drago P. A simulated comparison of the useful energy gain in a fixed and a fully tracking flat plate collector. *Solar Energy* 1978;20:419–23.
- [43] Gay CF, Yerkes JW, Wilson JH. Performance advantages of two-axis tracking for large flat-plate photovoltaic energy systems. In: Proceedings of the 16th photovoltaic specialists conference, San Diego, September 27–30, 1982; p. 1368–71.
- [44] Kvasznicza Z, Elmer G. Optimizing solar tracking systems for solar cells. In: The 4th Serbian–Hungarian joint symposium on intelligent systems; 2006.
- [45] Clifford MJ, Eastwood D. Design of a novel passive solar tracker. *Solar Energy* 2004;77:269–80.
- [46] Mwithiga G, Kigo SN. Performance of a solar dryer with limited sun tracking capability. *Journal of Food Engineering* 2006;74:247–52.
- [47] Poulek V. Testing the new solar tracker with shape memory alloy actors. Conference Record of the Twenty Fourth; IEEE Photovoltaic Specialists Conference 1994;1:1131–3.
- [48] Heredia IL, Moreno JM, Magalhaes PH, Cervantes R, Quéméré G, Laurent O. *Inspira's CPV sun tracking (concentrator photovoltaics)*. Springer; 2007; p. 221–51.
- [49] Abdallah S, Nijmeh S. Two axes sun tracking system with PLC control. *Energy Conversion and Management* 2004;45:1931–9.
- [50] Mamlook R, Nijmeh S, Abdallah SM. A programmable logic controller to control two axis sun tracking system. *Information Technology Journal* 2006;5(6):1083–7.
- [51] Rumyantsev V, Chalov A, Ionova E, Larionov V, Andreev V. Concentrator PV modules with multi-junction cells and primary/secondary refractive optical elements. In: The 19th European photovoltaic solar energy conference; 2004.
- [52] Konar A, Mandal AK. Microprocessor based automatic sun-tracker. IEE Proceedings Part A Physical Science Measurement and Instrumentation Management and Education Reviews 1991;138(4):237–41.
- [53] Al-Mohamad A. Efficiency improvements of photo-voltaic panels using a sun-tracking system. *Applied Energy* 2004;79:345–54.
- [54] Abu-Khader MM, Badran OO, Abdallah S. Evaluating multi-axes sun-tracking system at different modes of operation in Jordan. *Renewable and Sustainable Energy Reviews* 2008;12:864–73.
- [55] Bingol O, ALTINTAŞA, ÖNER Y. Microcontroller based solar-tracking system and its implementation. *Journal of Engineering Sciences* 2006;12(2):243–8.
- [56] Koyuncu B, Balasubramanian K. A microprocessor controlled automatic sun-tracker. *IEEE Transactions on Consumer Electronics* 1991;37(4):913–7.
- [57] Peterson T, Rice J, Valane J. Solar tracker; 2005. <http://lrc.cit.cornell.edu/courses/ee476/FinalProjects/s2005/tp62/website/solartracker>.
- [58] Debasol, solar power. Solar tracker; 2007. www.girasolar.com.
- [59] Contreras A, Garcia J, Gonzalez C, Martinez E. Portable solar tracker; May 08, 2006. http://engineering.utsa.edu/ee/sd/projects/spring2006/13/Team_13_Final_Presentation.
- [60] Abdallah S. The effect of using sun tracking systems on the voltage–current characteristics and power generation of flat plate PV. *Energy Conversion and Management* 2004;45:1671–9.
- [61] Rosell JI, Vallverdu X, Lecho MA, Ibanez M. Design and simulation of a low concentrating PV/thermal system. *Energy Conversion and Management* 2005;46:3034–46.
- [62] Lakeou S, Ososanya E, Latigo BO, Mahmoud W, Karanga G, Oshumare W. Design of a low-cost digital controller for a solar tracking photo-voltaic (PV) module and wind turbine combination system. In: 21st European PV solar energy conference; 2006.
- [63] Lakeou S, Ososanya E, Latigo BO, Mahmoud W. Design of a low-cost solar tracking photo-voltaic (PV) module and wind turbine combination system. 21st European Photovoltaic Solar Energy Conference, 4–8 September, 2006, Dresden, Germany.
- [64] Hamilton SJ. Sun-tracking solar cell array system. Bachelor of Engineering Thesis Division of Electrical Engineering. Department of Computer Science & Electrical Engineering, University of Queensland; October 1999.
- [65] Zeroual A, Raoufi M, Ankrim M, Wilkinson AJ. Design and construction of a closed loop sun-tracker with microprocessor management. *Solar Energy* 1998;19(4):263–74.
- [66] Jinayim T, Arunrungrasmi S, Tanitteeapan T, Mungkung N. Highly efficient low power consumption tracking solar cells for white LED-based lighting system.. *International Journal of Electrical Computer and Systems Engineering* 2007;1(2):1307–5179.
- [67] Hatfield P. Low cost solar tracker. Bachelor of Electrical Engineering Thesis, Department of Electrical and Computer Engineering, Curtin University of Technology; October 2006.
- [68] Huang BJ, Sun FS. Feasibility study of one-axis three positions tracking solar PV with low concentration ratio reflector. *Energy Conversion and Management* 2007;48:1273–80.
- [69] Kalogirou SA. Design and construction of a one-axis sun-tracking. *Solar Energy* 1996;57(6):465–9.
- [70] Khalifa A-JN, Al-Mutawalli SS. Effect of two-axis sun tracking on the performance of compound parabolic concentrators. *Energy Conversion and Management* 1998;39(10):1073–9.
- [71] Lynch WA, Salameh ZM. Simple electro-optically controlled dual-axis sun tracker. *Solar Energy* 1990;45(2):65–9.
- [72] Aiuchi K, Yoshida K, Onozaki M, Katayama Y, Nakamura M, Nakamura K. Sensor-controlled heliostat with an equatorial mount. *Solar Energy* 2006;80:1089–97.
- [73] Rumyantsev VD. Terrestrial concentrator PV systems (book chapter); 2007. p. 151–74. <http://www.springerlink.com/content/r7244751j441832zv/>.
- [74] Gagliano S, Savalli N, Tina G, Pitrone N. Two-axis sun tracking system: design and simulation. In: *Eurosun 2006*; 2006.
- [75] Zogbi R, Laplaze D. Design and construction of a sun tracker. *Solar Energy* 1984;33(3/4):369–72.
- [76] Rumala S-SN. A shadow method for automatic tracking. *Solar Energy* 1986;37(3):245–7.
- [77] Urbano JA, Matsumoto Y, Asomoza R, Aceves FJ, Sotelo A, Jacome A. 5 Wp PV module-based stand-alone solar tracking system. In: Proceedings of the 3rd world conference of photovoltaic energy conversion, vol. 3, nos. 12–16; May 2003. p. 2463–5.
- [78] Palavras I, Bakos GC. Development of a low-cost dish solar concentrator and its application in zeolite desorption. *Renewable Energy* 2006;3:2422–31.
- [79] Abouzeid M. Use of a reluctance stepper motor for solar tracking based on a programmable logic array (PLA) controller. *Renewable Energy* 2001;23:551–60.
- [80] Poulek V, Libra M. A very simple solar tracker for space and terrestrial applications. *Solar Energy Materials & Solar Cells* 2000;60:99–103.
- [81] Karimov KhS, Saqib MA, Akhter P, Ahmed MM, Chatthad JA, Yousafzai SA. A simple photo-voltaic tracking system. *Solar Energy Materials & Solar Cells* 2005;87:49–59.
- [82] Poulek V, Libra M. New solar tracker. *Solar Energy Materials and Solar Cells* 1998;51:113–20.
- [83] Canada J, Utrillas MP, Lozano JAM, Pedros R, Amo JLG, Maj A. Design of a sun tracker for the automatic measurement of spectral irradiance and construction of an irradiance database in the 330–1100 nm range. *Renewable Energy* 2007;32:2053–68.
- [84] Edwards BP. Computer based sun following system. *Solar Energy* 1978;21:491–6.
- [85] Alata M, Al-Nimr MA, Qaroush Y. Developing a multipurpose sun tracking system using fuzzy control. *Energy Conversion and Management* 2005;46:1229–45.
- [86] Aliman O, Daut I, Isa M, Adzman MR. Simplification of sun tracking mode to gain high concentration solar energy. *American Journal of Applied Sciences* 2007;4(3):171–5.
- [87] Nuwayhid RY, Mrad F, Abu-Said R. The realization of a simple solar tracking concentrator for university research applications. *Renewable Energy* 2001;24:207–22.
- [88] AL-Jumaily KEJ, AL-Kaysi MKA. The study of the performance and efficiency of flat linear Fresnel lens collector with sun tracking system in Iraq. *Renewable Energy* 1998;14(14):41–8.

- [89] Abdallah S, Badran OO. Sun tracking system for productivity enhancement of solar still. *Desalination* 2008;220:669–76.
- [90] Davies PA. Sun tracking mechanism using equatorial and ecliptic axes. *Solar Energy* 1993;50(6):487–9.
- [91] Blanco-Muriel M, Alarcon-Padilla DC, Lopez- Moratalla T, Lara-Coira M. Computing the solar vector. *Solar Energy* 2001;70(5):431–41.
- [92] Koyuncu B, Balasubramanian K. A microprocessor controlled automatic sun tracker. *IEEE Transactions* 1991;37(4):913–7.
- [93] Roth P, Georgiev A, Boudinov H. Design and construction of a system for sun-tracking. *Renewable Energy* 2004;29:393–402.
- [94] Ajay K, Nagaraju J. Micro-controller based sun tracker for line focus concentrating collectors. *Journal of the Solar Energy Society of India* 2003;13(1&2):1–8.
- [95] Rubio FR, Ortega MG, Gordillo F, Lopez-Martinez M. Application of new control strategy for sun tracking. *Energy Conversion and Management* 2007;48:2174–84.
- [96] Bakos GC. Design and construction of a two-axis sun tracking system for parabolic trough collector (PTC) efficiency improvement. *Renewable Energy* 2006;31:2411–21.
- [97] Hession PJ, Bonwick WJ. Experience with a sun tracker. *Solar Energy* 1984;32(1):3–11.
- [98] Luque-Heredia I, Gordillo F, Rodriguez F. A PI based hybrid sun tracking algorithm for photovoltaic concentration. In: *Proceedings of the 19th European PV solar energy conference and exhibition*; 2004.
- [99] Georgiev A, Roth P, Olivares A. Sun following system adjustment at the UTFSM. *Energy Conversion and Management* 2004;45:1795–806.
- [100] Durisch W, Urban J, Smestad G. Characterization of solar cells and modules under actual operating conditions, WREC. In: *Proceedings of the WREC-IV world renewable energy congress*; 1996. p. 359–66.
- [101] Saxena AK, Dutta V. A versatile microprocessor based controller for solar tracking. New Delhi, India: Photovoltaic Laboratory, Centre for Energy Studies, Indian Institute of Technology; 1990. p. 1105–9.